

FQ-41006 (A、D、E、 H、I、K、B6、B14、 B15) 生产工艺废气排 放口 废气排放标准 	电炉污染物排放标准(气) (GB-21900-2008)、《大气污染物排放标准》(DB44/727-2001) (工艺废气大气污染物排放 限值)第二阶段的二类标准较严者,如有新标准,按新标准执行			
污染物名称	浓度限值	污染物名称	浓度限值	浓度限值
氯化氢	[0.30] 毫克/立方米	硫酸雾	[0.30] 毫克/立方米	

FC-41006 (B13、01-012) 粉尘排放口 废气排放标准	电镀锌污染物排放标准(气)(GB-21900-2008)、《大气污染物排放标准》(DB44/27-2001)(工艺废气大气污染物排放限值)第二阶段的二级标准较严者,如有新标准,按新标准执行			
	污染物名称	浓度限值	污染物名称	浓度限值
颗粒物	[0.120] 毫克/立方米			

废水处理系统恶臭气体排放标准 (GB 14554-93) 二级标准, 如有新标准, 按新标准执行		浓度限值		浓度限值	
污染物名称	浓度限值	污染物名称	浓度限值	污染物名称	浓度限值
臭	[0.1-5] 毫瓦/立方米				

附件三 危废合同

工业危险废物处置合同
Contract for Disposal of Hazardous Waste

合同编号: [PUR-FY18-0459]

Reference No.[PUR-FY18-0459]

本工业危险废物处置合同(以下简称“本合同”)由以下双方于【2017】年【12】月【18】日在【 珠海 】共同签署:

This Industrial Hazardous Waste Disposal Contract (the “Contract”) is entered into in [*Zhuhai*] on the date of Dec.18th,2017, by and between the following two parties:

甲方 Party A:

【珠海斗门超毅实业有限公司】【Multek Industries Limited】

地址 Address: 中国广东省珠海市斗门区井岸镇新青科技园超毅厂房

【珠海硕鸿电路板有限公司】【Multek Zhuhai Limited】

地址 Address: 中国广东省珠海市西区三灶镇海澄工业区第 101 栋硕鸿工业大厦

【德丽科技(珠海)有限公司】【Multek China Limited】

地址 Address: 中国广东省珠海市斗门区井岸镇珠峰大道 168 号新青科技园

法定代表人 Legal representative: Manny Marimuthu

邮政编码 Post Code: 519180

电话号码 Tel: 5529226

传真号码 Fax: 5553114

具体联系人 Contact Person: Cherry Zhen

乙方 Party B:

【珠海市彩虹环保开发有限公司】

Zhuhai New Rainbow Environmental Protection Development Co., Ltd

法定代表人 Legal representative: 彭华真

地址 Address: 中国广东省珠海市斗门区珠港斗门区珠港大道北三村工业区北区

邮政编码 Post Code: 519175

电话号码 Tel: 0756-5655183 5652898

传真号码 Fax: 5654568

具体联系人 Contact Person: 凌周华 林土龙

PUR-FY18-0459 P1

本合同下的甲方的权益可由上述各方单独或联合行使,但相关责任和义务仅由发生交易关系的该方自行承担,甲方下的各方不承担连带责任。

Rights of Part A under this contract can be exercised by the abovementioned respectively or jointly, while no several and jointly liability will be imposed on the abovementioned parties.

鉴于:

Whereas:

一、 甲方是一家根据中国法律依法设立并有效存续的有限责任公司,其因公司生产管理需要委托他方进行工业危险废物收集、处置:

Party A is a duly established and validly existing limited liability company under PRC laws, and desires to seek treatment and disposal services of industrial hazardous waste generated from production.

二、 乙方是一家根据中国法律依法设立并有效存续的有限责任公司,持有《危险废物经营许可证》,可从事危险废物的收集、贮存和处置:

Party B is a duly established and validly existing limited liability company under PRC laws, and is possessing the Hazardous Waste Comprehensive Operation Permit and permitted to engage in collection, store and disposal services of hazardous waste.

三、 现乙方同意提供,甲方同意接受,根据本合同的条款和条件就甲方在生产过程中生产的工业危险废物(包括固废和废液)的收集和处置事宜由乙方方向甲方提供相应服务。

Party B agrees to provide, and Party A agrees to accept, the collection and disposal services of the industrial hazardous waste (including solid and liquid waste) generated during production of Party A according to the terms and conditions of this Contract.

为此,根据《中华人民共和国固体废物污染环境防治法》、《危险废物经营许可证管理办法》、《危险化学品安全管理条例》和《道路危险货物运输管理规定》等相关法律规定,甲、乙双方经友好协商,本着平等互利的原则订立本合同。

PUR-FY18-0459 P2

Therefore, in consideration of the foregoing, and for good and valuable consideration, and according to Law of the People's Republic of China on Prevention of Environmental Pollution Caused by Solid Waste, Measures for Administration of Hazardous Waste Operation Permits, Regulations on Prevention and Control of pollution of Solid Waste of Guangdong, Safety Regulations for Hazardous Chemical Goods and Regulations for Management of Road Hazardous Freight and other relevant laws, both parties hereby agree as follows:

一、 合同标的及价格 Subject Matter and Contract Price

- 1.1 本合同项下乙方负责为甲方处理的工业废物、废料的品种及收费标准详见下表：
The types and price of the industrial waste and waste materials disposal services to be retained by Party A are described in the table below.

序号	废物名称	Name of Waste	废物编号	计量单位	回收处理价
			No. of Waste	Unit	Price for Recycling and Disposal
1	表面处理废物	Surface treatment waste	HW17	KG	详见附件一 refer to exhibit 1
2	废电池	Scrap battery	HW23	KG	详见附件一 refer to exhibit 1
3	表面处理废物(废石英砂)	Surface treatment waste (Scrap sand)	HW17	Ton	详见附件一 refer to exhibit 1
4	污泥-生化污泥	Biochemical sludge	HW17	Ton	详见附件一 refer to exhibit 2
5	WTP-污泥	WTP-Sludge	HW17	Ton	详见附件一 refer to exhibit 1

- 1.2 上述价格为本合同最终价格, 包括装卸车劳务费、运输费、申报费、监测费等履行本合同的所有费用, 甲方无需向乙方支付任何其他费用。

The above price is the final Contract Price of this contract, including fees and expenses of

PUR-FY18-0459 P3

unloading, transportation, declaration, supervision and any other amount concerning the performance of this Contract. Party A is not obliged to make any other payment to Party B.

二、 合同期限 Contract Term

2.1 本合同期限为【一】年，自 2018 年 1 月 1 日起至 2018 年 12 月 31 日止。

The Contract Term is one year, which is from Jan.1st,2018 to Dec.31st,2018.

2.2 本合同期满后，经甲方同意，双方经友好协商可续签合同。

This Contract may be renewed upon amicably negotiation by the parties, after the expiration of the Contract.

三、 结算方式及付款 Payment and Settlement

3.1 A、付款方为甲方的结算方式：

双方于每月【15】日（遇法定节假日顺延至下一个工作日）按照双方记录单中记录的实际收运数量，对上个月处理的废物数量进行核对，经甲方确认，并甲方出具订购单后，乙方开具相应金额的正式商业发票，甲方核对无误后，在收到乙方发票后【90】日内以转账方式将该款项支付给乙方：

A、 Payment made by Party A:

On or before the【15】 day of each month (which shall be extended until the next working day in case of public holiday), both parties shall carry out verification of quantity of disposed waste of last month according to the actual quantity as reported in Recording List. After Party A confirmed by issuing PO, the amount of payment correctly invoiced by Party B shall be payable by Party A via bank transfer within ninety (90) days of Party A's receipt of each invoice.

B、付款方为乙方的结算方式：

双方于每月【10】日（遇法定节假日顺延至下一个工作日）按照双方记录单中记录的实际收运数量，对上月处理的废物数量进行核对，经双方确认后，甲方扣除乙方应支付款项，如预付款项不足实际货款金额，乙方在双方确认后5日内以转账方式将确认的款项全额支付给甲方，甲方确认收款后开具相应金额的正式商业发票。

B、 Payment Made By Party B:

PUR-FY18-0459 P4

On or before the 【10th】 day of each month (which shall be extended until the next working day in case of public holiday), both parties shall carry out verification of quantity of disposed waste of last month according to the actual quantity as reported in recording List. The amount of payment correctively Invoice by Party A shall be payable by Party B via bank transfer within 5 days (Party B fully pay within 5 days if deposit in account less than actual amount), and Party A issue Invoice against receive of payment.

3.2 乙方应于本合同生效之日起【3】日内向甲方支付人民币【300,000】元（叁拾万元整）作为履约保证金，其中支付甲方（珠海斗门超毅实业有限公司）：人民币【100,000】元整，[珠海硕鸿电路板有限公司]：人民币【100,000】元整，德丽科技（珠海）有限公司：人民币【100,000】元整，甲方有权根据实际交易情况调整押金金额，乙方应于甲方通知日起【3】日内向甲方支付调整后押金金额。若因乙方违反合同义务导致本合同解除，甲方有权没收上述履约保证金。本合同终止后若双方未续签合同，甲方扣除乙方应支付的罚款及其他应付款项后，将保证金剩余金额无息退还乙方。

Party B shall make payment of deposit to Party A, Which equals to RMB 300,000 (In capital: RMB300,000), within 3 days upon effective of this contract (Party B Shall make payment to Party A, 【Multek industries Limited】:RMB【100,000】，【Multek Zhuhai Limited】: RMB【100,000】，【Multek China Limited】: RMB【100,000】). Party A reserve the right to adjust deposit amount base on actual transaction, Party B shall make payment base on adjusted deposit amount within 3 days upon request From Party A, if this contract is terminated due to Party B'S breach of contract ,Party A is entitled to seize the deposit, If this contract is not renewed by both parties, the deposit shall be paid net to Party B after deduction of any penalty or payable amount of Party B.

3.3 尽管有相反规定，甲方有权拒付存在争议的服务费并有权扣除乙方应付的任何违约金、罚款及费用。若服务费及押金不足支付，乙方应在30日内支付不足部分。

Notwithstanding anything to the contrary in this Contract, Party A may deduct from such amount any amount that Party B is obligated to pay Party A under this Contract; if no further payments are due to Party B, Party B shall pay such amounts to Party A within thirty (30) days.

四、 废物交接、收集及处置 Delivery, Collection and Disposal of Waste

PUR-FY18-0459 PS

- 4.1 交接《国家危险废物名录》上的废物时，双方必须认真填写《危险废物转移联单》各栏目内容，双方盖章后由相关一方按照有关规定送交环保部门，交接双方须核对废物种类、数量，填写交接单据并作相关记录。乙方必须严格遵照法律、法规要求在交接当日向甲方提供《危险废物转移联单》。

Both parties shall duly fill in the Delivery Sheet of Hazardous Waste and submit it to environmental authority after stamped by both parties when making delivery of the wastes which are listed on the National Catalogue of Hazardous Wastes. Both parties shall duly verify and record the types and quantities of the waste and fill in relevant delivery sheet. Party B shall strictly comply with the laws and regulations and provide the Delivery Sheet of Hazardous Waste to Party A on the delivery date.

- 4.2 乙方必须按照相关环境保护法律法规的规定收集、装车、运输和处置甲方产生的废弃物，不得随意倾倒、遗撒、溢漏或者丢弃废弃物。乙方应协助甲方做好废弃物收集、运输和处置过程的运行跟踪记录，并根据甲方要求提供书面记录证明。

Party B shall collect, load, transit and dispose of the waste generated by Party A during production according to relevant environmental laws and regulations. It shall not dump, dose or discard the waste random. Party B shall assist Party A with tracking records of the collection, transportation and disposal of the waste and provide written record upon request of Party A.

- 4.3 乙方在甲方厂区内收集废弃物时，甲方需派相关人员(财务、行政、安全、仓库)在现场与乙方共同核实数据，核准后双方共同填写《工业危险废物处置记录单》，各自保留数据及记录。

Party A shall designate personnel to participate in verifying the waste when Party B is collecting waste in the factory area of Party A. Both parties shall fill in Recording List of Disposal of Industrial Hazardous Waste and preserve the records respectively.

- 4.4 乙方保证运输废弃物的车辆必须车况良好，采取符合安全、环保和运输标准的相关措施，用于危险化学品运输工具的槽罐以及其他容器必须符合相关法律法规的规定及标准，适于运输本合同规定的废物且必须持有危运证。

Party B warrants that the vehicles for carrying waste shall be in good condition and satisfy with relevant regulations and standards of safety transportation and environment protection.

PUR-FY18-0459 P6

The tanks and any other container used for carrying hazardous chemical shall be complied with the requirements and standards stipulated in relevant laws and regulations and shall be suitable for transporting the waste specified in this Contract with a valid license for road transportation of hazardous goods.

- 4.5 乙方应派人员跟进甲方废弃物的产生情况,保证废弃物储存到甲方确定的一定量后立即安全地装运、清空。

Party B shall send personnel to follow up with the waste generating procedure of Party A and assure the wastes are immediately packaged and cleaned when it reaches a certain amount of quantity designated by Party A.

- 4.6 危险化学品的装卸作业必须在装卸管理人员的现场指挥下进行。运输危险化学品的驾驶员、装卸人员和押运人员必须了解所运载的危险化学品的性质、危害特性、包装容器的使用特性和发生意外时的应急措施。运输危险化学品,必须配备必要的应急处理器材和防护用品。

The loading and unloading of hazardous chemicals shall be conducted at the presence and command of Party A's loading and unloading management personnel. The driver, loading and unloading personnel and escort personnel shall have a full understanding of the characteristic, characteristics of hazardousness of the hazardous chemical carrying, the application characteristic of the package and container, and the applicable emergency measures.

- 4.7 运输危险化学品的槽罐以及其他容器必须封口严密,能够承受正常运输条件下产生的内部压力和外部压力,保证危险化学品在运输中不因温度、湿度或者压力的变化而发生任何渗(洒)漏。

The tanks and other containers which carrying the hazardous chemicals shall be sealed tightly and shall endure internal and external pressure generated during the course of transportation. They shall also ensure the hazardous chemicals will not change or leak because of the change of temperature, humidity or pressure during transit.

- 4.8 乙方应保证在甲方提出相关要求后,到达现场的收集时间不得超过【1】个小时,乙方延迟提供服务的,应按照本合同第7.8条规定向甲方支付罚款。若遇甲方有特殊情况需要紧急处置(如重要客户参观),乙方应全力配合。

Party B warrants that it shall arrive the site for collection within 1 hour upon request of Party

PUR-FY18-0459 P7

- A. In case of delay, Party B shall pay penalty to Party A according to Article 7.8 of this Contract. If there is any emergent situation which requires immediate disposal of waste by Party A (e.g., VIP visit), Party B shall use its best endeavor to support.
- 4.9 乙方按国家有关规定,对甲方的工业危险废弃物进行安全无害化处置,废弃物自装车起,收集、运输和处置过程中的所有风险及责任均由乙方自行承担。
- Party B shall carry out non-polluted disposal of hazardous industrial waste of Party A according to relevant national regulations. The all risks of loss and liabilities shall be transferred to Party B upon loading of the waste.

五、 甲方权利及义务 Rights and Obligations of Party A

- 5.1 甲方将在生产加工过程中产生的废物交由乙方处理,采取合理措施协助乙方进行废弃物的收集、处置。
- Party A will deliver the waste which are generated during production to Party B for disposal, and take proper measures to assist Party A to collect and dispose of the waste.
- 5.2 甲方须将各种废物在乙方指导下严格按不同品种分别包装、存放,并贴上标签(标签内容包括废物名称、数量、注意事项等),保证废物包装完好及封口紧密,防止所盛装的废物泄漏污染环境,盛装危险废物的容器由【乙方负责提供】。
- All wastes shall be duly packaged by Party A under Party B's instruction. Each package shall be labeled and marked to identify the name, quantity of the waste and precautions. The containers carrying the waste shall be provided by [Party B].
- 5.3 若乙方对于废物提出书面异议,甲方应在合理时间内负责处理。
- If Party B raises any objection in writing to the waste, Party A shall reply to it within a reasonable time.

六、 乙方权利及义务 Rights and Obligations of Party B

- 6.1 乙方应遵守与提供本合同项下服务有关的法律、法规及甲方的规章制度,并保证其履行本合同的行为不会导致甲方违反相关法律。
- Party B shall abide by relevant laws, regulations and Party A's rules and policies in association with the services provided herein. Party B warrants that its performance of this

Contract will not cause Party A's violation of relevant laws and regulations.

- 6.2 在合同有效期内，乙方必须保证所持的处置废弃物的相应资质、证照及所有提供之证书均为有效存在，并提供所有相关文件的复印件给甲方备案。否则，甲方有权随时解除本合同，并要求乙方赔偿给甲方造成的全部损失。

Party B warrants that it has the capability and permits of disposal of waste, which shall be continually valid and effective during Contract Term. It will provide Party A all relevant permits and certificates for record purpose. Otherwise, Party A is entitled to terminate this Contract and seek compensation from Party B for all loss incurred.

- 6.3 乙方保证其驾驶人员、装卸管理人员和押运人员接受过有关法律、法规、规章和安全知识、专业技术、职业卫生防护和应急救援知识的培训，并经考核合格，具备相应从业资格证书。

Party B warrants that all of its drivers, loading and unloading personnel and escort personnel are well-educated and have a proper training of laws, regulations, rules, safety knowledge, professional technique, professional health protection and emergency treatment. The above personnel are all professionally qualified and hold professional certificates.

- 6.4 乙方明白本合同项下废物的特点和性质，以及由该废物或处理程序所导致或引起的健康、安全和环境危害及发生意外时的应对措施，并具备收集和处置本合同项下废弃物所需的专门技术、人员、设备、设施及处理场地。

Party B understands the characteristic and nature of the waste under this Contract and the emergency treatment related to any accident which will cause damage to personal health, safety and environment. It is capable to offer collecting and disposal service for the waste under this Contract by being equipped with professional technique, personnel, facilities, instruments and sites.

- 6.5 乙方应以熟练的、合格的、专业的方式提供服务，保证其在本合同下提供的所有服务符合相应的工业标准以及甲方的要求，并无能为甲方提供专业指导。

Party B will perform the service in a professional and workmanlike manner in accordance with the industrial standards and requirements of Party A and will provide Party A with professional instruction.

- 6.6 乙方应按照甲方的要求提供其经相关环保部门认可的有关废弃物处理的资质证明或材

PUR-FY18-Q459 P9

料供甲方备案，以配合甲方满足相关法规、政府要求和 ISO14001 管理体系标准。

Party B shall furnish to Party A, at Party A's option, all qualification or materials acknowledged and issued by environmental authorities in order to assist Party A's compliance to regulation, authority's requirement, and ISO14001 management system standard.

- 6.7 乙方在废物无害化处理过程中，应符合国家法律规定的运输、环保和消防要求或标准，甲方有权但并非有责任监督和指导乙方的工作。

Party B shall carry out non-polluted disposal in accordance with transportation, environmental and fire protection requirements or standards stipulated by laws. Party A may supervise Party B's Service.

- 6.8 乙方的员工或代理人必须在甲方指定的地点进行收集和装运作业。非经甲方同意或指示，乙方的员工或代理人不得进入甲方车间或仓库，且乙方的员工或代理人不得在甲方厂区内吸烟用火。乙方人员作业时，应遵守甲方的安检及相关内部管理规定。

Party B's employee or agent shall carry out collecting and loading in the place designated by Party A. Unless otherwise agreed by Party A, such employee or agent shall comply with the Party A's internal regulations and is not allowed to enter the workshop or warehouse of Party A, or smoke within factory area of Party A.

- 6.9 乙方保证不与甲方监督人员勾结，发生谎报数量的行为。

Party B warrants that it will not collude with Party A's personnel to falsify the quantity of waste.

- 6.10 乙方必须购买行业通常要求的保险，支付保险费用。保险事故发生时，乙方有责任尽力采取必要的措施，防止或者减少损失。

At all times during the effective term of this Contract (and any renewal thereof), Party B shall maintain insurance policies with reputable insurers of the types and amounts generally taken out for businesses in its industry at its own expenses, including but not limited to insurance covering liabilities for accidental personal injuries. When the accident takes place, Party B shall try its best to take necessary measure to prevent or mitigate the loss.

七、 违约责任 Liabilities of Breach of Contract

- 7.1 乙方应确保甲方不因下列事项受到损害，并同意就甲方因此遭受的任何或全部损失、损

PUR-FY18-0459 P10

害、支出或费用赔偿甲方，以使甲方免受损失：

Party B agrees to indemnify, defend and hold Party A harmless from and against any and all loss, damage, settlement or expense related to

(1) 乙方在本合同项下的行为侵犯第三人的权利；

Any infringement of a third party's rights by Party B;

(2) 乙方违反本合同规定的权利保证及服务保证；

Party B's breach of warranties and representations as specified in this Contract;

(3) 乙方的故意或过失行为；

Party B's willful misconduct or negligence;

(4) 可归责于乙方的人身伤亡和财产损失；或

Any personal injuries or property damage caused by the reasons attributable to Party B;
or

(5) 乙方或受乙方控制的第三人履行本合同的措施或未能履行本合同或其作为或不作为。

The performance of or failure to perform this Contract by Party B or any person under its control, or the act or omission of Party B or by anyone under Party B's control;

7.2 乙方如违反本合同约定，未按时、按质履行合同义务，由此给甲方造成损失的，乙方应负责进行赔偿。

If Party B fails to perform its obligations hereunder this Contract, which, as a consequence, cause damage to Party A, Party B shall compensate all loss incurred.

7.3 如乙方回收废弃物应按本合同第 3.1.(1)条规定按期支付回收价款，逾期付款的，每逾期一日，应向甲方支付应付款项的【0.5】%的违约金；乙方逾期付款超过【15】日的，甲方有权解除合同并要求乙方赔偿其所遭受的全部损失。

In case Party B recycles the waste, Party B shall make payment of recycling according to Article 3.1.(1) within specified time. If Party B fails to make such payment, for each day of delay, it shall pay an amount equivalent to 0.5% of payable amount to Party A as penalty. If the payment is in delay for over 15 days, Party A is entitled to terminate this Contract and seek compensation from Party B for all loss suffered.

7.4 乙方违反本合同约定，影响甲方正常生活或生产经营的，甲方有权要求乙方在一定期限

PUR-FY18-0459 P11

- 内解决，逾期未解决的，甲方有权终止合同，并要求乙方赔偿甲方全部经济损失。
- If Party B is in breach of this Contract which adversely affects the normal business and production of Party A, Party A is entitled to require Party B to correct the failure within a time limit. If Party B fails to correct the failure within the time limit, Party A is entitled to terminate this Contract and seek compensation from Party B for all economic loss suffered.
- 7.5 乙方处理甲方之废弃物违反本合同约定及国家、地方相关之法律法规规定，须自行承担一切法律责任，如致甲方利益受到损害，乙方须承担赔偿责任。
- Party B shall bear all legal liabilities of any violation of states and local laws and regulations in performing its service under this Contract. It shall be responsible for all damage suffered by Party A therefrom.
- 7.6 若由于乙方未及时、充分履行本合同项下义务而导致甲方遭受环保等相关主管部门罚款或其他处罚的，乙方应承担全部罚款，并赔偿甲方由此遭受的其他损失。
- Party B will indemnify and hold Party A harmless from any loss incurred or penalty punished by environment or other related authorities in connection with any breach of Party B in performing its obligation under this Contract.
- 7.7 乙方在甲方厂区收集废弃物时应采取相应的安全措施，由于乙方原因给甲方设施、材料或甲方人员造成财产损失或人身伤亡的，乙方应承担赔偿责任。
- Party B shall take proper safety precautions during waste collection within Party A's factory area. If any damage is caused to the facilities, materials, or property of Party A, or in case of any personal injury of Party A, Party B shall be responsible for compensation.
- 7.8 本合同有效期内，若乙方有任何违反国家、当地环保法律法规或严重违反合同条款的行为而导致甲方名誉、经济上的任何损失，视情节严重程度甲方有权处以人民币【2000】元以上，【20万】元以下的相应罚款，罚款直接从押金中扣除，且甲方有权终止该合同并保留追究乙方法律责任的权利，罚款不足抵扣的，乙方应在接到甲方通知后【3】日内支付不足款项。
- During the Contract Term, in case of any reputation damage or monetary loss to Party A, which is caused by Party B's violation of any state or local environmental laws and regulations or serious breach of the terms of this Contract, it may be fined an amount from RMB2,000 to RMB 200,000 according to the actual situation, at Party A's sole discretion. The

PUR-FY18-0459 P12

fine can be deducted from the deposit directly. Party A reserves the right to terminate this Contract and claim damages from Party B. If the amount of deposit is not enough to cover the penalty, Party B shall make payment of the balance within 3 days upon receipt of notice from Party A.

7.9 如甲方因乙方违反环保规定而遭到第三方向其提出的任何诉讼、索赔或行为,乙方应向甲方赔偿其由此遭受的任何或全部损失、损害、支出或费用。

Party B shall defend, indemnify and hold Party A harmless from and against the payment of damages, costs, expenses, liabilities and settlement amounts incurred in connection with any suit, claim or action by any third party arising from violation of environmental laws and regulation by Party B.

7.10 乙方同意以合理的详细程度,对于任何针对乙方提起的可能对甲方接受本合同服务造成不利影响的威胁、警告或侵权索赔通知,或针对其采取的行动,立即书面通知甲方。

Party B shall issue a prompt written notice to Party A describing the details of any suit, claim, threat, warning or action by any third party against Party B which may have an adverse impact on Party A's acceptance of service under the Contract

7.11 如果乙方未遵守本合同的义务和保证,除本合同规定的救济措施外,甲方还有权要求乙方重新提供服务,并自行承担费用。

If Party B is in breach of any terms or warranties of this Contract, in addition to the remedies specified in this Contract, Party A may require Party B re-providing the service at its own expense.

7.12 其他: 无

Miscellaneous: Nil

八、 不可抗力 Force Majeure

8.1 凡因发生严重自然灾害、战争,或其他不能预见、不能避免并不能克服的客观情况致使任何一方不能履行本合同时,遇有上述不可抗力的一方,应尽其努力减轻影响并应立即用邮递或传真通知对方,并应在三十日内提供不可抗力的详情及合同不能全部/部分履行或需延期履行理由的证明文件。该项证明文件应由不可抗力发生地区的公证机关出具,如无法

PUR-FY18-0459 P13

获得公证出具的证明文件，则提供其他有力证明。遭受不可抗力的一方由此而免责，但任何一方迟延履行后发生不可抗力的，不能免除责任。

If any party fails to perform its obligations under this Contract by reason of any act of God, wars or any other objective cause which is unforeseeable, unavoidable and insurmountable, it shall use its best endeavor to mitigate the influence and inform the other party by mail or facsimile, and, within 30 days, submit proofing documents describing details of the Force Majeure event, and reasons for being unable to perform all and partial obligations hereunder or any delay in performance. Such proofing documents shall be issued by the public notary office where the Force Majeure takes place. If such documents cannot be obtained, other proofing documents showing the same shall be submitted. The non-performing party shall not be deemed in breach of this Contract. Nevertheless, if any failure of performance occurs prior to such Force Majeure, such party shall still be liable for its failure.

8.2 因不可抗力致使本合同在该不可抗力事件发生后三十日内仍无法履行，非受不可抗力影响的一方有权终止本合同。

Regardless of the excuse of Force Majeure, if such party is not able to perform within thirty (30) days after such event, the other party may terminate the Contract

九、 保密 Confidentiality

9.1 双方应切实遵守保密协议/条款中约定的保密义务。

Both parties shall duly comply with the confidential obligations under the Confidential Agreement/Clause.

9.2 乙方不得使用甲方的中英文名称和商标，未经甲方事先书面同意，乙方不得在其广告、宣传或其他公开资料中使用、注明甲方的中英文名称。

Party B may not use the Chinese or English name, logo, trademark or other symbol of Part A in publicity releases or advertising without the prior written consent of Party A.

9.3 除非双方另有书面约定，乙方不应向第三方披露或公开宣称如下事项：（a）双方正在或即将进行某种磋商，或双方缔结某种合作关系的可能性；或（b）双方即将缔结、或已缔结、或已终止某种合作关系。

PUR-FY18-0459 P14

- Unless otherwise agreed by both parties in writing, Party B shall not release or disclose: (1) the negotiation is taking place or is going to take place, or the possibility of contract relationship between parties, or (2) the contract relationship between parties is going to be established, or has been established, or is terminated.
- 9.4 各方在讨论、订立及履行本合同过程中甲方向乙方提供的全部技术和商业信息、本合同的内容及本合同的存在均应被视为保密信息（“保密信息”）。
- Confidential Information (“Confidential Information”) means all technical and commercial information disclosing by Party A to Party B during the negotiation, execution and performance of this Contract, including the contents and the existence of this Contract.
- 9.5 对于甲方向乙方提供的保密信息，乙方负有保密义务，未经甲方事先书面同意，乙方不得以任何形式向任何第三方披露。乙方仅应为履行本合同的目的使用保密信息。乙方应采取必要合理的措施保护甲方的保密信息。乙方不应应对披露方保密信息进行任何性质的反向工程。
- Party B shall keep confidential of any Confidential Information disclosed by Party A. Party B shall not, without Party A's written permission, disclose the Confidential Information to any third party in any form. Party B shall use the Confidential Information for the purposes specifically authorized under this Contract. Party B shall establish and maintain safeguards against the release of the Confidential Information of Party A. Party B warrants that it will not develop reverse engineering against any Confidential Information of Party A.
- 9.6 无论是否属于“保密信息”，乙方应就其拥有或控制的甲方数据采取其保护自身数据类似的防护措施，以免甲方数据信息遭受破坏、丢失或者被改写。本条所称的“甲方数据”指乙方直接或间接通过甲方或代表甲方得到的任何形式的有关甲方的网站、雇员及承包商、或其他由甲方的信息系统所生成、储存的甲方资源数据及信息。乙方除了用于提供本合同项下的服务外，不得将“甲方数据”用于其它任何目的；甲方数据为甲方的财产，乙方不得将任何甲方数据以出售、转让、出租或者其他任何方式向第三方予以处置，或者用于商业开发。乙方亦无权就甲方数据享有或设定任何留置权。
- Whether or not Confidential Information, Party B shall establish and maintain safeguards against the destruction, loss or alternation of Party A's Data in Party B's possession or control to the extent which are no less rigorous than those maintained by Party B for its own data of a

PUR-FY18-0459 P15

similar nature. "Party A's Data" means all data and information in any form, made available to Party B, directly or indirectly, by or on behalf of Party A, including derivative works of such data and any data or information pertaining to Party A's site, Party A's employee and contractors, Party A's equipment or other resources that is entered into, stored in or generated by Party B's information systems. Party A's Data will be and remain the property of Party A. Party B may not use Party A's Data for any purpose other than to render the Services hereunder. No Party A's Data will be sold, assigned, leased or otherwise disposed of to third parties or commercially exploited by or on behalf of Party B. Party B may not possess or assert any lien or other right against or to Party A's Data.

- 9.7 违反本条款约定的，乙方应当向甲方支付人民币【100】万元作为违约金，如乙方支付的违约金不足抵付甲方损失的，乙方还应赔偿造成的损失与违约金的差额部分。

If Party B is in breach of this Article, it shall pay penalty in the amount of RMB 1 million to Party A. If the penalty is not enough to cover all losses suffered by Party A, Party B shall be responsible for the balance between the actual loss and the penalty.

十、 合同变更和终止 Modification and Termination of Contract

- 10.1 合同期内，本合同任何一方不得擅自变更或解除本合同，但本合同另有约定的除外。

Either party shall not terminate or amend this Contract during contract term, unless otherwise stipulated hereunder.

- 10.2 尽管有上述约定，甲方可出于自身便利提前【30】日发出书面通知单方终止本合同。

Notwithstanding the above 10.1, Party A may terminate this Contract for its convenience upon 30 days prior written notice.

- 10.3 除本合同规定的情形，乙方不得擅自解除本合同。乙方无正当理由提前终止合同的，应向甲方支付人民币【50】万元作为违约金；给甲方造成经济损失超过违约金的，还应对超过部分给予赔偿。

Unless otherwise stipulated in this Contract, Party B shall not terminate this Contract unilaterally. If Party B terminates this Contract without reasonable ground, it shall make payment in the amount of RMB500,000 to Party A as penalty. If the actual economic loss incurred is more than such amount of penalty, Party B shall be also responsible for such

PUR-FY18-0459 P16

excess part.

10.4 若发生以下任一情形，各方均有权向对方发出书面通知以提前终止本合同：

Either party is entitled to unilaterally terminate this Contract prior to contract term by written notice if any of the following events takes place:

(1) 对方实质性违反本合同的约定，致使本合同无法履行，且自其收到本方发出指出其违约的书面通知起五日内亦未弥补此违约行为；

The other party is in material breach of this Contract and the Contract cannot be fulfilled provided that the other party has not cured the failure within 5 days from the date of receipt of the written notice indicating such failure.

(2) 对方破产，或已进入破产或其他类似性质的程序；

The other party is bankrupt, or is in bankruptcy procedure or other similar procedure.

(3) 对方决定解散或清算；

The other party decides to dissolve or liquidate.

(4) 对方实质性股权变更，包括被接管或与其他公司合并。

There is a material change of shareholding of the other party, including takeover or merger by third party.

10.5 本合同一旦终止或甲方发现乙方有任何违反本合同约定的行为，乙方应立即向甲方退还全部甲方为执行本合同向乙方提供的各种文档、资料、器件、工具、设备、仪器及其他物品，并返还甲方保密信息及其全部副本。

Party B agrees that upon termination of this Contract or in the event that its conducts are discovered to be in breach of the Contract by Party A, it will promptly return to Party A all materials provided by Party A to Party B, including documents, materials, devices, tools, instruments and any other materials containing or disclosing any confidential or proprietary information of Party A.

10.6 本合同提前终止的，除截至终止日甲方对乙方应付而未付的款项外，未向乙方支付的费用甲方不再支付。

If this Contract is terminated prior to the contract term, Party A shall not make any payment to Party B, except for the payment due and payable on and prior to the termination date of this Contract.

PUR-FY18-0459 P17

十一、 争议解决 Dispute Resolution

11.1 甲、乙双方应通过直接的友好协商解决本合同中所发生的或与本合同有关的一切争端。

Both parties shall firstly try to solve the dispute arising from or in connection with this Contract by amicable negotiation.

11.2 如从该协商开始后 30 日内甲方和乙方仍不能友好解决合同争端，双方同意采取如下第【2】种方式解决争议：

If the parties fail to resolve any disputes arising from or in connection with this Agreement within 30 days after the negotiation, it is agreed that the dispute will be resolved in accordance with the [2] method as below:

1) 提交中国国际经济贸易仲裁委员会在北京根据其届时有效的仲裁规则予以仲裁。仲裁裁决是终局的，对双方都具有约束力，胜诉方有权向有管辖权的法院申请执行仲裁裁决；

The dispute will be resolved by binding arbitration conducted in Beijing, in accordance with the rules and procedures of China International Economic and Trade Arbitration Commission. The arbitration award is final and binding upon both parties. The prevailing party in such arbitration shall be entitled to apply for enforcement of the award in the people's court which has jurisdiction.

2) 向甲方所在地有管辖权的人民法院提起诉讼。

The dispute will be resolved by litigation in the people's court, which is located in Party A's registered place and may exercise its jurisdiction over the dispute.

11.3 在仲裁或诉讼期间，除争议部分外，其他合同部分应继续执行。

During the proceedings of arbitration or litigation, the parties shall continue to perform this Contract except for the part in arbitration or litigation.

十二、 通知 Notification

PUR-FY18-0459 P18

- 12.1 本合同项下要求或允许的所有通知应以书面形式作出，并将在 (a) 如以专人递送，在送达时；(b) 如以传真方式发送，在确认发送时；(c) 如以挂号邮件或平信方式寄出 (要求回执、预付邮资)，在投寄后五 (5) 日；或 (d) 在交给商业性通宵服务速递公司后一 (1) 日视为送达。所有通信将送至本合同首部所列地址或一方根据本条规定经向另一方发出书面通知指定的其他地址。

All notices required or permitted under this Contract will be in writing and will be deemed received (a) when delivered personally; (b) when sent by confirmed facsimile; (c) five (5) days after having been sent by registered or certified mail, return receipt requested, postage prepaid; or (d) one (1) day after deposit with a commercial overnight carrier. All communications will be sent to the addresses set forth above or to such other address as may be designated by a party by giving written notice to the other party pursuant to this Article.

十三、其他 Miscellaneous

- 13.1 本合同自双方法定代表人或授权代表签字并盖章之日起生效。

This Contract is effective upon signing and stamping by legal representatives or authorized representative of both parties.

- 13.2 除经甲方事先书面同意外，乙方不得转让本合同项下的部分或全部权利及义务。但是，如果乙方未能提供甲方所要求的服务，甲方可以自行决定从第三方处获得替代性的服务。乙方应偿付甲方因此而支出的一切费用。前述甲方从第三方处获得替代性服务的行为，并不影响甲方就乙方未能提供本合同下服务而要求赔偿或承担有关责任的权利。

Party B may not assign or subcontract this Contract without prior consent of Party A. However, if Party B fails to provide services required by Party A, Party A, at its sole discretion, may find substitute service provider. Party B shall be liable for all expense suffered by Party A. The above action by Party A does not exempt Party B from the liability and obligation due to its failure of providing service hereunder.

- 13.3 尽管有前述规定，甲方有权将本合同项下的部分或全部权利和义务转让给其关联公司，或通过并购、合并、股权交换、出售或处置资产（包括清算过程中的处置）转让本合同项下的全部或部分权利义务。

Notwithstanding the aforementioned stipulations, this Contract may be assigned by Party A in

PUR-FY18-0459 P19

whole or in part to Party A's current and future sites, affiliates and subsidiaries, or through merger, consolidation, exchange of shares, or sale or other disposition of assets, including disposition on dissolution.

- 13.4 合同履行期间，双方如有任何修改或补充意见，应协商一致签订修改或补充协议。修改或补充协议是本合同的组成部分，签字盖章后与本合同具有同等法律效力。

If there is any revision or amendment of this Contract, both parties shall sign an amendment or supplementary contract. The amendment or supplementary contract is a part of this Contract, and will have the same effect with this Contract after due execution by the parties.

- 13.5 本合同所有附件为本合同不可分割部分，与本合同具有同等的法律效力，若本合同条款与附件存有不符，以本合同条款为准。本合同条款及附件汇集并代替了本合同签订前双方关于本合同标的的所有口头或书面的协议、协商、会谈纪录、声明、备忘录以及相互承诺的一切文件。

Any and all annexes to this Contract shall be an indispensable part of this Contract, and have the same legal effect with this Contract. If there is any conflict and discrepancy between this Contract and its annexes, this Contract shall prevail. This Contract and its annexes supersede all previous agreements, promises, proposals, representations, understanding and negotiations, whether written or oral, between the parties respecting the subject matter hereof.

- 13.6 本合同中任何被视作无效或不可执行的部分，将不会影响本合同其他条款或部分的有效性与可执行性。

In the event any one or more of the provisions of this Contract shall for any reason be held to be invalid, illegal or unenforceable, the remaining provisions of this Contract shall be unimpaired.

- 13.7 本合同中的各节标题只是为方便所设，并不应影响本合同的理解或解释。

The headings in this Contract are for purposes of reference only and shall not in any way limit or affect the meaning or interpretation of any terms hereof.

- 13.8 任何一方履行本合同项下义务均应作为独立合同人。本合同所载任何内容不应被解释为在双方间创设雇佣、合资、合伙、代理或任何其它本合同目的以外的关系。

The relationship of both parties shall at all times be that of independent contractors. Nothing herein shall be deemed to establish a partnership, joint venture, association or employment

PUR-FY18-0459 P20

- relationship between the parties.
- 13.9 一方未能或延迟行使其在本合同下的权利，不能解释为其弃权。
Neither party's failure or delay to enforce, at any time, any rights under this Contract shall be construed to be a waiver of such right.
- 13.10 甲、乙双方之间的清廉关系是彼此真诚合作的基础。基于非清廉关系对双方真诚合作都是不利的，现双方承诺：任何一方不向对方工作人员或者与对方利益有关关系的第三方（如财务顾问、法律顾问等）提供商业贿赂或者其他任何形式的利益。该等利益包括但不限于礼品、馈赠、小费、现金、样品、物品回扣、回扣等，其中馈赠包括但不限于免费娱乐、免费旅游等；同时，请客也是一种馈赠，双方员工共同进餐应各付其款。否则，违约方之行为构成违约，守约方有权单方解除合同且要求违约方做出赔偿。
Both parties warrant and covenant that none of their employees, agents or representatives have been offered, shall be offered, have received, or shall receive, directly or indirectly, any benefit, fee, commission, dividend, gift, or consideration of any kind in connection with this Contract. Neither party will at any time, treat for meal, offer gratuities or any merchandise, cash, services, or other inducements to each other's employees. Violation of this provision shall be grounds for immediate termination of this Contract and a refund of all amounts paid hereunder.
- 13.11 本合同适用中华人民共和国法律并依据其予以解释。
This Contract shall be governed and interpreted by the laws of People's Republic of China.
- 13.12 本合同一式【五】份，甲、乙双方各执【一】份，其余份数根据有关规定送交环保部门审批存档，均具有同等法律效力。
This Contract is executed in five original copies. Each party shall retain one fully executed original. The other three original copies will be submitted to environmental department for filing. Each of the original fully executed copies of this Contract shall constitute an original for any and all enforcement purpose.
- 13.13 本合同及其附件中文字为中文，若有英文文本，仅供参考。如中、英文本在描述和含义上有矛盾之处，以中文文本为准。
This Contract and its annexes are written in Chinese language. The English version (if any) is made for reference only. If there is any inconsistency between two versions, the Chinese

PUR-FY18-0459 P21

version shall prevail.

13.14 本合同未尽事宜，双方友好协商解决。

If there is any issue not covered by this Contract, both parties shall negotiate amicably.

FUR-FY18-0459 P22

合同签署页
(Signature page)

甲方
珠海斗门超毅实业有限公司
珠海硕鸿电路板有限公司
德丽科技(珠海)有限公司



(盖章) (Stamp)
授权代表 (签字)
Authorized representative:
(Signature)
日期: 2017年12月27日
Date:

乙方
珠海市新虹环保开发有限公司

Party B
New Rainbow Environmental
Protection Development Co., Ltd



(盖章) (Stamp)
授权代表 (签字)
Authorized representative:
(Signature)
日期: 2017年12月27日
Date:

PUR-FY18-0459 P23

工业危险废物处置合同
Contract for Disposal of Hazardous Waste

合同编号: [PUR-FY18-0478]

Reference No.[PUR-FY18-0478]

本工业危险废物处置合同(以下简称“本合同”)由以下双方于【2018】年【01】月【01】日在【**珠海**】共同签署:

This Industrial Hazardous Waste Disposal Contract (the “Contract”) is entered into in [**Zhuhai**] on the date of Jan.1th,2018 by and between the following two parties:

甲方 Party A:

【德丽科技(珠海)有限公司】【Multek China Limited】

地址 Address: 中国广东省珠海市斗门区井岸镇珠峰大道168号新青科技工业园

法定代表人 Legal representative: Manny Marimuthu

邮政编码 Post Code: 519180

电话号码 Tel: 5529226

传真号码 Fax: 5553114

具体联系人 Contact Person: cherry zhen



17GDZHJD00029D1

乙方 Party B:

【江门市东江环保技术有限公司】

【Jiangmen City Dongjiang Environmental Technology Co., Ltd.】

法定代表人 Legal representative: 李永鹏

地址 Address: 江门市鹤山市鹤城镇东坑村委石旗山

邮政编码 Post Code: 529727

电话号码 Tel: 0756-7736148 / 15920258758

传真号码 Fax: 0756-7736428

具体联系人 Contact Person: 吕华伟

PUR-FY18-0478 P1

本合同下的甲方的权益可由上述各方单独或联合行使,但相关责任和义务仅由发生交易关系的该方自行承担,甲方下的各方不承担连带责任。

Rights of Part A under this contract can be exercised by the abovementioned respectively or jointly, while no several and jointly liability will be imposed on the abovementioned parties.

鉴于:

Whereas:

一、 甲方是一家根据中国法律依法设立并有效存续的有限责任公司,其因公司生产管理需要委托他方进行工业危险废物收集、处置;

Party A is a duly established and validly existing limited liability company under PRC laws, and desires to seek treatment and disposal services of industrial hazardous waste generated from production.

二、 乙方是一家根据中国法律依法设立并有效存续的有限责任公司,持有《危险废物综合经营许可证》,可从事危险废物的收集、贮存和处置;

Party B is a duly established and validly existing limited liability company under PRC laws, and is possessing the Hazardous Waste Comprehensive Operation Permit and permitted to engage in collection, store and disposal services of hazardous waste.

三、 现乙方同意提供,甲方同意接受,根据本合同的条款和条件就甲方在生产过程中生产的工业危险废物(包括固废和废液)的收集和处置事宜由乙方向甲方提供相应服务。

Party B agrees to provide, and Party A agrees to accept, the collection and disposal services of the industrial hazardous waste (including solid and liquid waste) generated during production of Party A according to the terms and conditions of this Contract.

为此,根据《中华人民共和国固体废物污染环境防治法》、《危险废物经营许可证管理办法》、《危险化学品安全管理条例》和《道路危险货物运输管理规定》等相关法律规定,甲、乙双方经友好协商,本着平等互利的原则订立本合同。

PUR-FY18-0478 P2

Therefore, in consideration of the foregoing, and for good and valuable consideration, and according to Law of the People's Republic of China on Prevention of Environmental Pollution Caused by Solid Waste, Measures for Administration of Hazardous Waste Operation Permits, Regulations on Prevention and Control of pollution of Solid Waste of Guangdong, Safety Regulations for Hazardous Chemical Goods and Regulations for Management of Road Hazardous Freight and other relevant laws, both parties hereby agree as follows:

一、 合同标的及价格 Subject Matter and Contract Price

1.1 本合同项下乙方负责为甲方处理的工业废物、废料的品种及收费标准详见下表:

The types and price of the industrial waste and waste material's disposal services to be retained by Party A are described in the table below.

序号	废物名称	Name of Waste	废物编号 No. of Waste	计量单位 Unit	回收处置含税单价 price for recycling and disposal (RMB include VAT)
1	水晶胶空瓶	Empty bottle of crystal glue	HW49	PCS	详见附件 1
2	200 升大桶	200L barrel	HW49	PCS	详见附件 1
3	小铁桶	Small iron barrel	HW49	PCS	详见附件 1
4	CP 桶/颗粒桶	CP barrel	HW49	PCS	详见附件 1
5	白色空桶	White barrel	HW49	PCS	详见附件 1
6	杂色胶桶	Mottle barrel	HW49	PCS	详见附件 1
7	显定影空桶(5L 小胶桶)	Develop & fixation barrel (5L)	HW49	PCS	详见附件 1
8	废油罐	Scrap oil can	HW49	KG	详见附件 1
9	锡膏空瓶	Solder paste bottle	HW49	PCS	详见附件 1
10	方形大白桶	Square white barrel	HW49	PCS	详见附件 1
11	废氧化铝(表面处理废渣)	Scrap aluminium oxide	HW17	KG	详见附件 1
12	废洗网水	Used stencil cleaning solvent	HW06	KG	详见附件 1

PUR-FY18-0478 P3

13	废矿物油	Scrap oil	HW08	KG	详见附件 1
14	含镍废液	Waste water with Ni	HW17	Ton	详见附件 1
15	有机除油废液	Waste liquid from organic PTH cleaner	HW17	Ton	详见附件 1
16	沉钨废液	Waste liquid from PTH stabilizer	HW17	Ton	详见附件 1
17	氧化废液	Waste liquid from black oxide	HW17	Ton	详见附件 1
18	废硝酸废水	Waste water with HNO3 and Ni	HW17	Ton	详见附件 1
19	含锡废液	SCRAP LIQUID WITH Tin	HW17	Ton	详见附件 1
20	酸性蚀刻液	ACID ETCH LIQUID	HW22	Ton	详见附件 1
21	硫酸铜废水	WASTE WATER OF CU ₂ SO ₄	HW22	Ton	详见附件 1

- 1.2 上述价格为本合同最终价格，包括装卸车劳务费、运输费、申报费、监测费等履行本合同的所有费用，甲方无需向乙方支付任何其他费用。
The above price is the final Contract Price of this contract, including fees and expenses of unloading, transportation, declaration, supervision and any other amount concerning the performance of this Contract. Party A is not obliged to make any other payment to Party B.

二、合同期限 Contract Term

- 2.1 本合同期限为【一】年，自 2018 年 1 月 1 日起至 2018 年 12 月 31 日止。

The Contract Term is one year, which is from Jan.1st2018 to Dec.31st2018 .

- 2.2 本合同期满后，经甲方同意，双方经友好协商可续签合同。

This Contract may be renewed upon amicably negotiation by the parties, after the expiration of the Contract.

三、结算方式及付款 Payment and Settlement

- 3.1 A、付款方为甲方的结算方式：

双方于每月【15】日（遇法定节假日顺延至下一个工作日）按照双方记录单中记录的实

PUR-FY18-0478 P4

际收运数量，对上个月处理的废物数量进行核对，经甲方确认，并甲方出具订购单后，乙方开具相应金额的正式商业发票，甲方核对无误后，在收到乙方发票后【60】日内以转账方式将该款项支付给乙方：

A、Payment made by Party A:

On or before the【15】 day of each month (which shall be extended until the next working day in case of public holiday), both parties shall carry out verification of quantity of disposed waste of last month according to the actual quantity as reported in Recording List. After Party A confirmed by issuing PO, the amount of payment correctly invoiced by Party B shall be payable by Party A via bank transfer within ninety (60) days of Party A's receipt of each invoice.

B、付款方为乙方的结算方式：

双方于每月【15】日（遇法定节假日顺延至下一个工作日）按照双方记录单中记录的实际收运数量，对上月处理的废物数量进行核对，经双方确认后，甲方扣除乙方应付款项，如预付款项不足实际货款金额，乙方在双方确认后15日内以转账方式将确认的款项全额支付给甲方，甲方确认收款后开具相应金额的正式商业发票。

B、Payment Made By Party B:

On or before the【15th】 day of each month (which shall be extended until the next working day in case of public holiday), both parties shall carry out verification of quantity of disposed waste of last month according to the actual quantity as reported in recording List. The amount of payment correctively invoice by Party A shall be payable by Party B via bank transfer within 5 days (Party B fully pay within 15 days if deposit in account less than actual amount), and Party A issue invoice against receive of payment.

3.2 尽管有相反规定，甲方有权拒付存在争议的服务费并有权扣除乙方应付的任何违约金、罚款及费用。若服务费及押金不足支付，乙方应在30日内支付不足部分。

Notwithstanding anything to the contrary in this Contract, Party A may deduct from such amount any amount that Party B is obligated to pay Party A under this Contract; if no further payments are due to Party B, Party B shall pay such amounts to Party A within thirty (30) days.

PUR-FY18-0478 P5

四、 废物交接、收集及处置 Delivery, Collection and Disposal of Waste

- 4.1 交接《国家危险废物名录》上的废物时，双方必须认真填写《危险废物转移联单》各栏目内容，双方盖章后由相关一方按照有关规定送交环保部门。交接双方须核对废物种类、数量，填写交接单据并作相关记录。乙方必须严格遵照法律、法规要求在交接当日向甲方提供《危险废物转移联单》。

Both parties shall duly fill in the Delivery Sheet of Hazardous Waste and submit it to environmental authority after stamped by both parties when making delivery of the wastes which are listed on the National Catalogue of Hazardous Wastes. Both parties shall duly verify and record the types and quantities of the waste and fill in relevant delivery sheet. Party B shall strictly comply with the laws and regulations and provide the Delivery Sheet of Hazardous Waste to Party A on the delivery date.

- 4.2 乙方必须按照相关环境保护法律法规的规定收集、装车、运输和处置甲方产生的废弃物，不得随意倾倒、遗撒、泼洒或者丢弃废弃物。乙方应协助甲方做好废弃物收集、运输和处置过程的运行跟踪记录，并根据甲方要求提供书面记录证明。

Party B shall collect, load, transit and dispose of the waste generated by Party A during production according to relevant environmental laws and regulations. It shall not dump, dose or discard the waste random. Party B shall assist Party A with tracking records of the collection, transportation and disposal of the waste and provide written record upon request of Party A.

- 4.3 乙方在甲方厂区内收集废弃物时，甲方需派相关人员(财务、行政、安全、仓库)在现场与乙方共同核实数据，核准后双方共同填写《工业危险废物处置记录单》，各自保留数据及记录。

Party A shall designate personnel to participate in verifying the waste when Party B is collecting waste in the factory area of Party A. Both parties shall fill in Recording List of Disposal of Industrial Hazardous Waste and preserve the records respectively.

- 4.4 乙方保证运输废弃物的车辆必须车况良好，采取符合安全、环保和运输标准的相关措施，用于危险化学品运输工具的槽罐以及其他容器必须符合相关法律法规的规定及标准，适于运输本合同规定的废物且必须持有危运证。

Party B warrants that the vehicles for carrying waste shall be in good condition and satisfy

PUR-FY18-0478 P6

with relevant regulations and standards of safety transportation and environment protection. The tanks and any other container used for carrying hazardous chemical shall be complied with the requirements and standards stipulated in relevant laws and regulations and shall be suitable for transporting the waste specified in this Contract with a valid license for road transportation of hazardous goods.

- 4.5 乙方应派人员跟进甲方废弃物的产生情况,保证废弃物储存到甲方确定的一定量后立即安全地装运、清空。

Party B shall send personnel to follow up with the waste generating procedure of Party A and assure the wastes are immediately packaged and cleaned when it reaches a certain amount of quantity designated by Party A.

- 4.6 危险化学品的装卸作业必须在装卸管理人员的现场指挥下进行。运输危险化学品的驾驶员、装卸人员和押运人员必须了解所运载的危险化学品的性质、危害特性、包装容器的使用特性和发生意外时的应急措施。运输危险化学品,必须配备必要的应急处理器材和防护用品。

The loading and unloading of hazardous chemicals shall be conducted at the presence and command of Party A's loading and unloading management personnel. The driver, loading and unloading personnel and escort personnel shall have a full understanding of the characteristic, characteristics of hazardousness of the hazardous chemical carrying, the application characteristic of the package and container, and the applicable emergency measures.

- 4.7 运输危险化学品的槽罐以及其他容器必须封口严密,能够承受正常运输条件下产生的内部压力和外部压力,保证危险化学品在运输中不因温度、湿度或者压力的变化而发生任何渗(洒)漏。

The tanks and other containers which carrying the hazardous chemicals shall be sealed tightly and shall endure internal and external pressure generated during the course of transportation. They shall also ensure the hazardous chemicals will not change or leak because of the change of temperature, humidity or pressure during transit.

- 4.8 乙方应保证在甲方提出相关要求后,到达现场的收集时间不得超过【2】个小时,乙方延迟提供服务的,应按照本合同第7.8条规定向甲方支付罚款。若遇甲方有特殊情况需要紧急处置(如重要客户参观),乙方应全力配合。

PUR-FY18-0478 P7

Party B warrants that it shall arrive the site for collection within 2 hour upon request of Party A. In case of delay, Party B shall pay penalty to Party A according to Article 7.8 of this Contract. If there is any emergent situation which requires immediate disposal of waste by Party A (e.g., VIP visit), Party B shall use its best endeavor to support.

4.9 乙方按国家有关规定,对甲方的工业危险废弃物进行安全无害化处置,废弃物自装车起,收集、运输和处置过程中的所有风险及责任均由乙方自行承担。

Party B shall carry out non-polluted disposal of hazardous industrial waste of Party A according to relevant national regulations. The all risks of loss and liabilities shall be transferred to Party B upon loading of the waste.

五、 甲方权利及义务 Rights and Obligations of Party A

- 5.1 甲方将在生产加工过程中产生的废物交由乙方处理,采取合理措施协助乙方进行废物的收集、处置。
- Party A will deliver the waste which are generated during production to Party B for disposal, and take proper measures to assist Party A to collect and dispose of the waste.
- 5.2 甲方须将各种废物在乙方指导下严格按不同品种分别包装、存放,并贴上标签(标签内容包括废物名称、数量、注意事项等),保证废物包装完好及封口紧密,防止所盛装的废物泄漏污染环境,盛装危险废物的容器由【乙方负责提供】。
- All wastes shall be duly packaged by Party A under Party B's instruction. Each package shall be labeled and marked to identify the name, quantity of the waste and precautions. The containers carrying the waste shall be provided by [Party B].
- 5.3 若乙方对于废物提出书面异议,甲方应在合理时间内负责处理。
- If Party B raises any objection in writing to the waste, Party A shall reply to it within a reasonable time.

六、 乙方权利及义务 Rights and Obligations of Party B

- 6.1 乙方应遵守与提供本合同项下服务有关的法律、法规及甲方的规章制度,并保证其履行本合同的行为不会导致甲方违反相关法律。
- Party B shall abide by relevant laws, regulations and Party A's rules and policies in

PUR-FY18-0478 P8

association with the services provided herein. Party B warrants that its performance of this Contract will not cause Party A's violation of relevant laws and regulations.

- 6.2 在合同的有效期内,乙方必须保证所持的处置废弃物的相应资质、证照及所有提供之证书均为有效存在,并提供所有相关文件的复印件给甲方备案。否则,甲方有权随时解除本合同,并要求乙方赔偿给甲方造成的全部损失。

Party B warrants that it has the capability and permits of disposal of waste, which shall be continually valid and effective during Contract Term. It will provide Party A all relevant permits and certificates for record purpose. Otherwise, Party A is entitled to terminate this Contract and seek compensation from Party B for all loss incurred.

- 6.3 乙方保证其驾驶人员、装卸管理人员和押运人员接受过有关法律、法规、规章和安全知识、专业技术、职业卫生防护和应急救援知识的培训,并经考核合格,具备相应从业资格证书。

Party B warrants that all of its drivers, loading and unloading personnel and escort personnel are well-educated and have a proper training of laws, regulations, rules, safety knowledge, professional technique, professional health protection and emergency treatment. The above personnel are all professionally qualified and hold professional certificates.

- 6.4 乙方明白本合同项下废物的特点和性质,以及由该废物或处理程序所导致或引起的健康、安全和环境危害及发生意外时的应对措施,并具备收集和处置本合同项下废弃物所需的专门技术、人员、设备、设施及处理场地。

Party B understands the characteristic and nature of the waste under this Contract and the emergency treatment related to any accident which will cause damage to personal health, safety and environment. It is capable to offer collecting and disposal service for the waste under this Contract by being equipped with professional technique, personnel, facilities, instruments and sites.

- 6.5 乙方应以熟练的、合格的、专业的方式提供服务,保证其在本合同下提供的所有服务符合相应的工业标准以及甲方的要求,并无偿为甲方提供专业指导。

Party B will perform the service in a professional and workmanlike manner in accordance with the industrial standards and requirements of Party A and will provide Party A with professional instruction.

PUR-FY18-0478 P9

- 6.6 乙方应按照甲方的要求提供其经相关环保部门认可的有关废弃物处理的资质证明或材料供甲方备案，以配合甲方满足相关法规、政府要求和 ISO14001 管理体系标准。
Party B shall furnish to Party A, at Party A's option, all qualification or materials acknowledged and issued by environmental authorities in order to assist Party A's compliance to regulation, authority's requirement, and ISO14001 management system standard.
- 6.7 乙方在废物无害化处理过程中，应符合国家法律规定的运输、环保和消防要求或标准，甲方有权但并非有责任监督和指导乙方的工作。
Party B shall carry out non-polluted disposal in accordance with transportation, environmental and fire protection requirements or standards stipulated by laws. Party A may supervise Party B's Service.
- 6.8 乙方的员工或代理人必须在甲方指定的地点进行收集和装运作业。非经甲方同意或指示，乙方的员工或代理人不得进入甲方车间或仓库，且乙方的员工或代理人不得在甲方厂区内吸烟用火。乙方人员作业时，应遵守甲方的安检及相关内部管理规定。
Party B's employee or agent shall carry out collecting and loading in the place designated by Party A. Unless otherwise agreed by Party A, such employee or agent shall comply with the Party A's internal regulations and is not allowed to enter the workshop or warehouse of Party A, or smoke within factory area of Party A.
- 6.9 乙方保证不与甲方监督人员勾结，发生谎报数量的行为。
Party B warrants that it will not collude with Party A's personnel to falsify the quantity of waste.
- 6.10 乙方必须购买行业通常要求的保险，支付保险费用。保险事故发生时，乙方有责任尽力采取必要的措施，防止或者减少损失。
At all times during the effective term of this Contract (and any renewal thereof), Party B shall maintain insurance policies with reputable insurers of the types and amounts generally taken out for businesses in its industry at its own expenses, including but not limited to insurance covering liabilities for accidental personal injuries. When the accident takes place, Party B shall try its best to take necessary measure to prevent or mitigate the loss.

七、 违约责任 Liabilities of Breach of Contract

PUR-FY18-0478 P10

7.1 乙方应确保甲方不因下列事项受到损害，并同意就甲方因此遭受的任何或全部损失、损害、支出或费用赔偿甲方，以使甲方免受损失：

Party B agrees to indemnify, defend and hold Party A harmless from and against any and all loss, damage, settlement or expense related to

(1) 乙方在本合同项下的行为侵犯第三人的权利；

Any infringement of a third party's rights by Party B;

(2) 乙方违反本合同规定的权利保证及服务保证；

Party B's breach of warranties and representations as specified in this Contract;

(3) 乙方的故意或过失行为；

Party B's willful misconduct or negligence;

(4) 可归责于乙方的人身伤亡和财产损失；或

Any personal injuries or property damage caused by the reasons attributable to Party B;
or

(5) 乙方或受乙方控制的第三人履行本合同的措施或未能履行本合同或其作为或不作为。

The performance of or failure to perform this Contract by Party B or any person under its control, or the act or omission of Party B or by anyone under Party B's control;

7.2 乙方如违反本合同约定，未按时、按质履行合同义务，由此给甲方造成损失的，乙方应负责进行赔偿。

If Party B fails to perform its obligations hereunder this Contract, which, as a consequence, cause damage to Party A, Party B shall compensate all loss incurred.

7.3 如乙方回收废弃物应按本合同第 3.1 条规定按期支付回收价款，逾期付款的，每逾期一日，应向甲方支付应付款项的【0.5】%的违约金；乙方逾期付款超过【15】日的，甲方有权解除合同并要求乙方赔偿其所遭受的全部损失。

In case Party B recycles the waste, Party B shall make payment of recycling according to Article 3.1 within specified time. If Party B fails to make such payment, for each day of delay, it shall pay an amount equivalent to 0.5% of payable amount to Party A as penalty. If the payment is in delay for over 15 days, Party A is entitled to terminate this Contract and seek compensation from Party B for all loss suffered.

PUR-FY18-0478 P11

- 7.4 乙方违反本合同约定,影响甲方正常生活或生产经营的,甲方有权要求乙方在一定期限内解决,逾期未解决的,甲方有权终止合同,并要求乙方赔偿甲方全部经济损失。
If Party B is in breach of this Contract which adversely affects the normal business and production of Party A, Party A is entitled to require Party B to correct the failure within a time limit. If Party B fails to correct the failure within the time limit, Party A is entitled to terminate this Contract and seek compensation from Party B for all economic loss suffered.
- 7.5 乙方处理甲方之废弃物违反本合同约定及国家、地方相关之法律法规规定,须自行承担一切法律责任,如致甲方利益受到损害,乙方须承担赔偿责任。
Party B shall bear all legal liabilities of any violation of states and local laws and regulations in performing its service under this Contract. It shall be responsible for all damage suffered by Party A therefrom.
- 7.6 若由于乙方未及时、充分履行本合同项下义务而导致甲方遭受环保等相关主管部门罚款或其他处罚的,乙方应承担全部罚款,并赔偿甲方由此遭致的其他损失。
Party B will indemnify and hold Party A harmless from any loss incurred or penalty punished by environment or other related authorities in connection with any breach of Party B in performing its obligation under this Contract.
- 7.7 乙方在甲方厂区收集废弃物时应采取相应的安全措施,由于乙方原因给甲方设施、材料或甲方人员造成财产损失或人身伤亡的,乙方应承担赔偿责任。
Party B shall take proper safety precautions during waste collection within Party A's factory area. If any damage is caused to the facilities, materials, or property of Party A, or in case of any personal injury of Party A, Party B shall be responsible for compensation.
- 7.8 本合同有效期内,若乙方有任何违反国家、当地环保法律法规或严重违反合同条款的行为而导致甲方名誉、经济上的任何损失,视情节严重程度甲方有权处以人民币【2000】元以上,【20万】元以下的相应罚款,罚款直接从押金中扣除,且甲方有权终止该合同并保留追究乙方法律责任的权利,罚款不足抵扣的,乙方应在接到甲方通知后【3】日内支付不足款项。
During the Contract Term, in case of any reputation damage or monetary loss to Party A, which is caused by Party B's violation of any state or local environmental laws and regulations or serious breach of the terms of this Contract, it may be fined an amount from

PUR-FY18-0478 P12

RMB2,000 to RMB 200,000 according to the actual situation, at Party A's sole discretion. The fine can be deducted from the deposit directly. Party A reserves the right to terminate this Contract and claim damages from Party B. If the amount of deposit is not enough to cover the penalty, Party B shall make payment of the balance within 3 days upon receipt of notice from Party A.

- 7.9 如甲方因乙方违反环保规定而遭到第三方向其提出的任何诉讼、索赔或行为,乙方应向甲方赔偿其由此遭受的任何或全部损失、损害、支出或费用。

Party B shall defend, indemnify and hold Party A harmless from and against the payment of damages, costs, expenses, liabilities and settlement amounts incurred in connection with any suit, claim or action by any third party arising from violation of environmental laws and regulation by Party B.

- 7.10 乙方同意以合理的详细程度,对于任何针对乙方提起的可能对甲方接受本合同服务造成不利影响的威胁、警告或侵权索赔通知,或针对其采取的行动,立即书面通知甲方。

Party B shall issue a prompt written notice to Party A describing the details of any suit, claim, threat, warning or action by any third party against Party B which may have an adverse impact on Party A's acceptance of service under the Contract

- 7.11 如果乙方未遵守本合同的义务和保证,除本合同规定的救济措施外,甲方还有权要求乙方重新提供服务,并自行承担费用。

If Party B is in breach of any terms or warranties of this Contract, in addition to the remedies specified in this Contract, Party A may require Party B re-providing the service at its own expense.

- 7.12 其他: 无

Miscellaneous: --NIL--

八、 不可抗力 Force Majeure

- 8.1 凡因发生严重自然灾害、战争,或其他不能预见、不能避免并不能克服的客观情况致使任何一方不能履行本合同时,遇有上述不可抗力的一方,应尽其努力减轻影响并应立即用邮递或传真通知对方,并应在三十日内提供不可抗力的详情及合同不能全部/部分履行或需延期履行理由的证明文件。该项证明文件应由不可抗力发生地区的公证机关出具,如无法

获得公证出具的证明文件，则提供其他有力证明。遭受不可抗力的一方由此而免责，但在任何一方迟延履行后发生不可抗力的，不能免除责任。

If any party fails to perform its obligations under this Contract by reason of any act of God, wars or any other objective cause which is unforeseeable, unavoidable and insurmountable, it shall use its best endeavor to mitigate the influence and inform the other party by mail or facsimile, and, within 30 days, submit proofing documents describing details of the Force Majeure event, and reasons for being unable to perform all and partial obligations hereunder or any delay in performance. Such proofing documents shall be issued by the public notary office where the Force Majeure takes place. If such documents cannot be obtained, other proofing documents showing the same shall be submitted. The non-performing party shall not be deemed in breach of this Contract. Nevertheless, if any failure of performance occurs prior to such Force Majeure, such party shall still be liable for its failure.

- 8.2 因不可抗力致使本合同在该不可抗力事件发生后三十日内仍无法履行，非受不可抗力影响的一方有权终止本合同。

Regardless of the excuse of Force Majeure, if such party is not able to perform within thirty (30) days after such event, the other party may terminate the Contract

九、 保密 Confidentiality

- 9.1 双方应切实遵守保密协议/条款中约定的保密义务。

Both parties shall duly comply with the confidential obligations under the Confidential Agreement/Clause.

- 9.2 乙方不得使用甲方的中英文名称和商标，未经甲方事先书面同意，乙方不得在其广告、宣传或其他公开资料中使用、注明甲方的中英文名称。

Party B may not use the Chinese or English name, logo, trademark or other symbol of Party A in publicity releases or advertising without the prior written consent of Party A.

- 9.3 除非双方另有书面约定，乙方不应向第三方披露或公开宣称如下事项：(a) 双方正在或即将进行某种磋商，或双方缔结某种合作关系的可能性；或 (b) 双方即将缔结、或已缔结、或已终止某种合作关系。

- Unless otherwise agreed by both parties in writing, Party B shall not release or disclose: (1) the negotiation is taking place or is going to take place, or the possibility of contract relationship between parties, or (2) the contract relationship between parties is going to be established, or has been established, or is terminated.
- 9.4 各方在讨论、订立及履行本合同过程中甲方向乙方提供的全部技术和商业信息、本合同的内容及本合同的存在均应被视为保密信息（“保密信息”）。
- Confidential Information (“Confidential Information”) means all technical and commercial information disclosing by Party A to Party B during the negotiation, execution and performance of this Contract, including the contents and the existence of this Contract.
- 9.5 对于甲方向乙方提供的保密信息，乙方负有保密义务，未经甲方事先书面同意，乙方不得以任何形式向任何第三方披露。乙方仅应为履行本合同的目的使用保密信息。乙方应采取必要合理的措施保护甲方的保密信息。乙方不应披露甲方保密信息进行任何性质的反向工程。
- Party B shall keep confidential of any Confidential Information disclosed by Party A. Party B shall not, without Party A’s written permission, disclose the Confidential Information to any third party in any form. Party B shall use the Confidential Information for the purposes specifically authorized under this Contract. Party B shall establish and maintain safeguards against the release of the Confidential Information of Party A. Party B warrants that it will not develop reverse engineering against any Confidential Information of Party A.
- 9.6 无论是否属于“保密信息”，乙方应就其拥有或控制的甲方数据采取其保护自身数据类似的防护措施，以免甲方数据信息遭受破坏、丢失或者被改写。本条所称的“甲方数据”指乙方直接或间接通过甲方或代表甲方得到的任何形式的有关甲方的网站、雇员及承包商、或其他由甲方的信息系统所生成、储存的甲方资源数据及信息。乙方除了用于提供本合同项下的服务外，不得将“甲方数据”用于其它任何目的；甲方数据为甲方的财产，乙方不得将任何甲方数据以出售、转让、出租或者其他任何方式向第三方予以处置，或者用于商业开发，乙方亦无权就甲方数据享有或设定任何留置权。
- Whether or not Confidential Information, Party B shall establish and maintain safeguards against the destruction, loss or alternation of Party A’s Data in Party B’s possession or control to the extent which are no less rigorous than those maintained by Party B for its own data of a

similar nature. "Party A's Data" means all data and information in any form, made available to Party B, directly or indirectly, by or on behalf of Party A, including derivative works of such data and any data or information pertaining to Party A's site, Party A's employee and contractors, Party A's equipment or other resources that is entered into, stored in or generated by Party B's information systems. Party A's Data will be and remain the property of Party A. Party B may not use Party A's Data for any purpose other than to render the Services hereunder. No Party A's Data will be sold, assigned, leased or otherwise disposed of to third parties or commercially exploited by or on behalf of Party B. Party B may not possess or assert any lien or other right against or to Party A's Data.

- 9.7 违反本条款约定的，乙方应当向甲方支付人民币【50】万元作为违约金，如乙方支付的违约金不足抵付甲方损失的，乙方还应赔偿造成的损失与违约金的差额部分。

If Party B is in breach of this Article, it shall pay penalty in the amount of RMB 700,000 to Party A. If the penalty is not enough to cover all losses suffered by Party A, Party B shall be responsible for the balance between the actual loss and the penalty.

十、 合同变更和终止 Modification and Termination of Contract

- 10.1 合同期内，本合同任何一方不得擅自变更或解除本合同，但本合同另有约定的除外。
Either party shall not terminate or amend this Contract during contract term, unless otherwise stipulated hereunder.
- 10.2 尽管有上述约定，甲方可出于自身便利提前【30】日发出书面通知单方终止本合同。
Notwithstanding the above 10.1, Party A may terminate this Contract for its convenience upon 30 days prior written notice.
- 10.3 除本合同规定的情形，乙方不得擅自解除本合同。乙方无正当理由提前终止合同的，应向甲方支付人民币【20】万元作为违约金；给甲方造成经济损失超过违约金的，还应对超过部分给予赔偿。

Unless otherwise stipulated in this Contract, Party B shall not terminate this Contract unilaterally. If Party B terminates this Contract without reasonable ground, it shall make payment in the amount of RMB700,000 to Party A as penalty. If the actual economic loss incurred is more than such amount of penalty, Party B shall be also responsible for such

excess part.

10.4 若发生以下任一情形，各方均有权向对方发出书面通知以提前终止本合同：

Either party is entitled to unilaterally terminate this Contract prior to contract term by written notice if any of the following events takes place:

(1) 对方实质性违反本合同的约定，致使本合同无法履行，且自其收到本方发出指出其违约的书面通知起五日内亦未弥补此违约行为；

The other party is in material breach of this Contract and the Contract cannot be fulfilled provided that the other party has not cured the failure within 5 days from the date of receipt of the written notice indicating such failure.

(2) 对方破产，或已进入破产或其他类似性质的程序；

The other party is bankrupt, or is in bankruptcy procedure or other similar procedure.

(3) 对方决定解散或清算；

The other party decides to dissolve or liquidate.

(4) 对方实质性股权变更，包括被接管或与其他公司合并。

There is a material change of shareholding of the other party, including takeover or merger by third party.

10.5 本合同一旦终止或甲方发现乙方有任何违反本合同约定的行为，乙方应立即向甲方返还全部甲方为执行本合同向乙方提供的各种文档、资料、器件、工具、设备、仪器及其他物品，并返还甲方保密信息及其全部副本。

Party B agrees that upon termination of this Contract or in the event that its conducts are discovered to be in breach of the Contract by Party A, it will promptly return to Party A all materials provided by Party A to Party B, including documents, materials, devices, tools, instruments and any other materials containing or disclosing any confidential or proprietary information of Party A.

10.6 本合同提前终止的，除截至终止日甲方对乙方应付而未付的款项外，未向乙方支付的费用甲方不再支付。

If this Contract is terminated prior to the contract term, Party A shall not make any payment to Party B, except for the payment due and payable on and prior to the termination date of this Contract.

PUR-FY18-0478 P17

十一、 争议解决 **Dispute Resolution**

11.1 甲、乙双方应通过直接的友好协商解决本合同中所发生的或与本合同有关的一切争端。
Both parties shall firstly try to solve the dispute arising from or in connection with this Contract by amicable negotiation.

11.2 如从该协商开始后 30 日内甲方和乙方仍不能友好解决合同争端，双方同意采取如下第【2】种方式解决争议：

If the parties fail to resolve any disputes arising from or in connection with this Agreement within 30 days after the negotiation, it is agreed that the dispute will be resolved in accordance with the [2] method as below:

1) 提交中国国际经济贸易仲裁委员会在北京根据其届时有效的仲裁规则予以仲裁。仲裁裁决是终局的，对双方都具有约束力，胜诉方有权向有管辖权的法院申请执行仲裁裁决：

The dispute will be resolved by binding arbitration conducted in Beijing, in accordance with the rules and procedures of China International Economic and Trade Arbitration Commission. The arbitration award is final and binding upon both parties. The prevailing party in such arbitration shall be entitled to apply for enforcement of the award in the people's court which has jurisdiction.

2) 向甲方所在地有管辖权的人民法院提起诉讼。

The dispute will be resolved by litigation in the people's court, which is located in Party A's registered place and may exercise its jurisdiction over the dispute.

11.3 在仲裁或诉讼期间，除争议部分外，其他合同部分应继续执行。

During the proceedings of arbitration or litigation, the parties shall continue to perform this Contract except for the part in arbitration or litigation.

十二、 通知 **Notification**

PUR-FY18-0478 P18

12.1 本合同项下要求或允许的所有通知应以书面形式作出, 并将在(a) 如以专人递送, 在送达时; (b) 如以传真方式发送, 在确认发送时; (c) 如以挂号邮件或平信方式寄出(要求回执、预付邮资), 在投寄后五(5)日; 或(d) 在交给商业性通宵服务速递公司后一(1)日视为送达。所有通信将送至本合同首部所列地址或一方根据本条规定经向另一方发出书面通知指定的其他地址。

All notices required or permitted under this Contract will be in writing and will be deemed received (a) when delivered personally; (b) when sent by confirmed facsimile; (c) five (5) days after having been sent by registered or certified mail, return receipt requested, postage prepaid; or (d) one (1) day after deposit with a commercial overnight carrier. All communications will be sent to the addresses set forth above or to such other address as may be designated by a party by giving written notice to the other party pursuant to this Article.

十三、其他 Miscellaneous

13.1 本合同自双方法定代表人或授权代表签字并盖章之日起生效。

This Contract is effective upon signing and stamping by legal representatives or authorized representative of both parties.

13.2 除经甲方事先书面同意外, 乙方不得转让本合同项下的部分或全部权利及义务。但是, 如果乙方未能提供甲方所要求的服务, 甲方可以自行决定从第三方处获得替代性的服务。乙方应偿付甲方因此而支出的一切费用。前述甲方从第三方处获得替代性服务的行为, 并不影响甲方就乙方未能提供本合同下服务而要求赔偿或承担有关责任的权利。

Party B may not assign or subcontract this Contract without prior consent of Party A. However, if Party B fails to provide services required by Party A, Party A, at its sole discretion, may find substitute service provider. Party B shall be liable for all expense suffered by Party A. The above action by Party A does not exempt Party B from the liability and obligation due to its failure of providing service hereunder.

13.3 尽管有前述规定, 甲方有权将本合同项下的部分或全部权利和义务转让给其关联公司, 或通过并购、合并、股权交换、出售或处置资产(包括清算过程中的处置)转让本合同项下的全部或部分权利义务。

Notwithstanding the aforementioned stipulations, this Contract may be assigned by Party A in

PUR-FY18-0478 P19

whole or in part to Party A's current and future sites, affiliates and subsidiaries, or through merger, consolidation, exchange of shares, or sale or other disposition of assets, including disposition on dissolution.

- 13.4 合同履行期间, 双方如有任何修改或补充意见, 应协商一致签订修改或补充协议。修改或补充协议是本合同的组成部分, 签字盖章后与本合同具有同等法律效力。

If there is any revision or amendment of this Contract, both parties shall sign an amendment or supplementary contract. The amendment or supplementary contract is a part of this Contract, and will have the same effect with this Contract after due execution by the parties.

- 13.5 本合同所有附件为本合同不可分割部分, 与本合同具有同等的法律效力, 若本合同条款与附件存有不符, 以本合同条款为准。本合同条款及附件汇集并代替了本合同签订前双方关于本合同的所有口头或书面的协议、协商、会谈纪录、声明、备忘录以及相互承诺的一切文件。

Any and all annexes to this Contract shall be an indispensable part of this Contract, and have the same legal effect with this Contract. If there is any conflict and discrepancy between this Contract and its annexes, this Contract shall prevail. This Contract and its annexes supersedes all previous agreements, promises, proposals, representations, understanding and negotiations, whether written or oral, between the parties respecting the subject matter hereof.

- 13.6 本合同中任何被视作无效或不可执行的部分, 将不会影响本合同其他条款或部分的有效性与可执行性。

In the event any one or more of the provisions of this Contract shall for any reason is held to be invalid, illegal or unenforceable, the remaining provisions of this Contract shall be unimpaired.

- 13.7 本合同中的各节标题只是为方便所说, 并不应影响本合同的理解或解释。

The headings in this Contract are for purposes of reference only and shall not in any way limit or affect the meaning or interpretation of any terms hereof.

- 13.8 任何一方履行本合同项下义务均应作为独立合同人。本合同所载任何内容不应被解释为在双方间创设雇佣、合资、合伙、代理或任何其它本合同目的以外的关系。

The relationship of both parties shall at all times be that of independent contractors. Nothing herein shall be deemed to establish a partnership, joint venture, association or employment

PUR-FY18-0478 P20

relationship between the parties.

- 13.9 一方未能或延迟行使其在本合同下的权利，不能解释为其弃权。

Neither party's failure or delay to enforce, at any time, any rights under this Contract shall be construed to be a waiver of such right.

- 13.10 甲、乙双方之间的清廉关系是彼此真诚合作的基础。基于非清廉关系对双方真诚合作都是不利的，现双方承诺：任何一方不向对方工作人员或者与对方利益有关关系的第三方（如财务顾问、法律顾问等）提供商业贿赂或者其它任何形式的利益，该等利益包括但不限于礼品、馈赠、小费、现金、样品、物品回佣、回扣等，其中馈赠包括但不限于免费娱乐、免费旅游等；同时，请客也是一种馈赠，双方员工共同进餐应各付其款。否则，违约方之行为构成违约，守约方有权单方解除合同且要求违约方做出赔偿。

Both parties warrant and covenant that none of their employees, agents or representatives have been offered, shall be offered, have received, or shall receive, directly or indirectly, any benefit, fee, commission, dividend, gift, or consideration of any kind in connection with this Contract. Neither party will at any time, treat for meal, offer gratuities or any merchandise, cash, services, or other inducements to each other's employees. Violation of this provision shall be grounds for immediate termination of this Contract and a refund of all amounts paid hereunder.

- 13.11 本合同适用中华人民共和国法律并依据其予以解释。

This Contract shall be governed and interpreted by the laws of People's Republic of China.

- 13.12 本合同一式【五】份，甲方执【二】份，乙方执【二】份，其余份数根据有关规定送交环保部门审批存档，均具有同等法律效力。

This Contract is executed in five original copies. Each party shall retain one fully executed original. The other three original copies will be submitted to environmental department for filing. Each of the original fully executed copies of this Contract shall constitute an original for any and all enforcement purpose.

- 13.13 本合同及其附件中文字为中文，若有英文文本，仅供参考。如中、英文本在描述和含义上有矛盾之处，以中文文本为准。

This Contract and its annexes are written in Chinese language. The English version (if any) is made for reference only. If there is any inconsistency between two versions, the Chinese

PUR-FY18-0478 P21

version shall prevail.

13.14 本合同未尽事宜，双方友好协商解决。

If there is any issue not covered by this Contract, both parties shall negotiate amicably.

PUR-FY18-0478 P22

125

合同签署页
(Signature page)

甲方
德丽科技（珠海）有限公司

乙方
江门市东江环保技术有限公司

Party A
Multek China Limited



(盖章) (Stamp)
授权代表 (签字):
Authorized representative:
(Signature)
日期: 年 月 日
Date:

Party B
Jiangmen City Dongjiang
Environmental Technology
Co., Ltd.



(盖章) (Stamp)
授权代表 (签字):
Authorized representative:
(Signature)
日期: 年 月 日
Date:

PUR-FY18-0478 P23

附件四 平面布置图

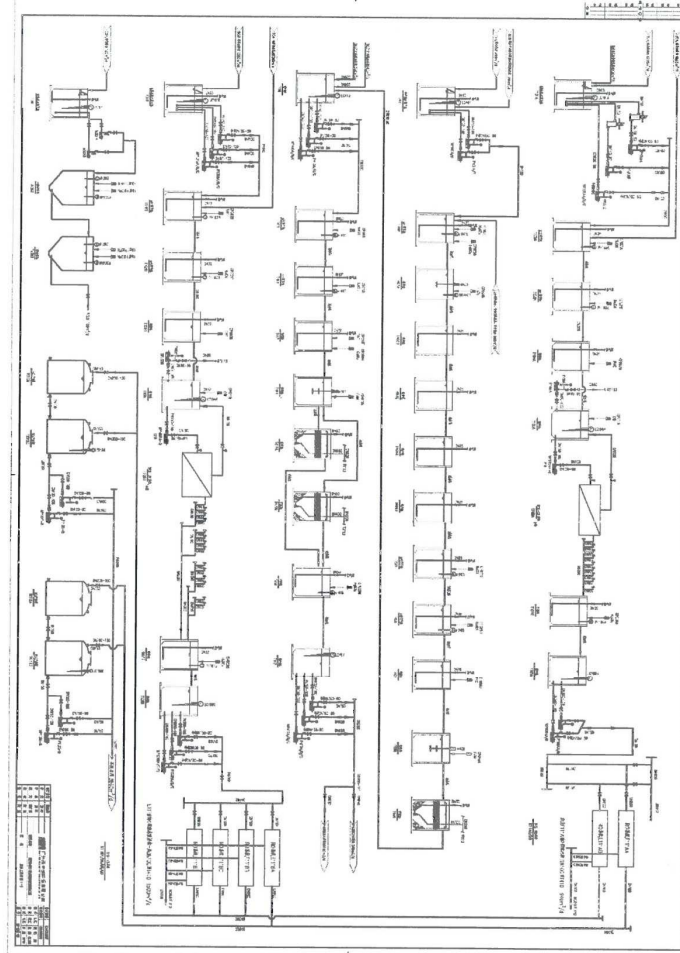

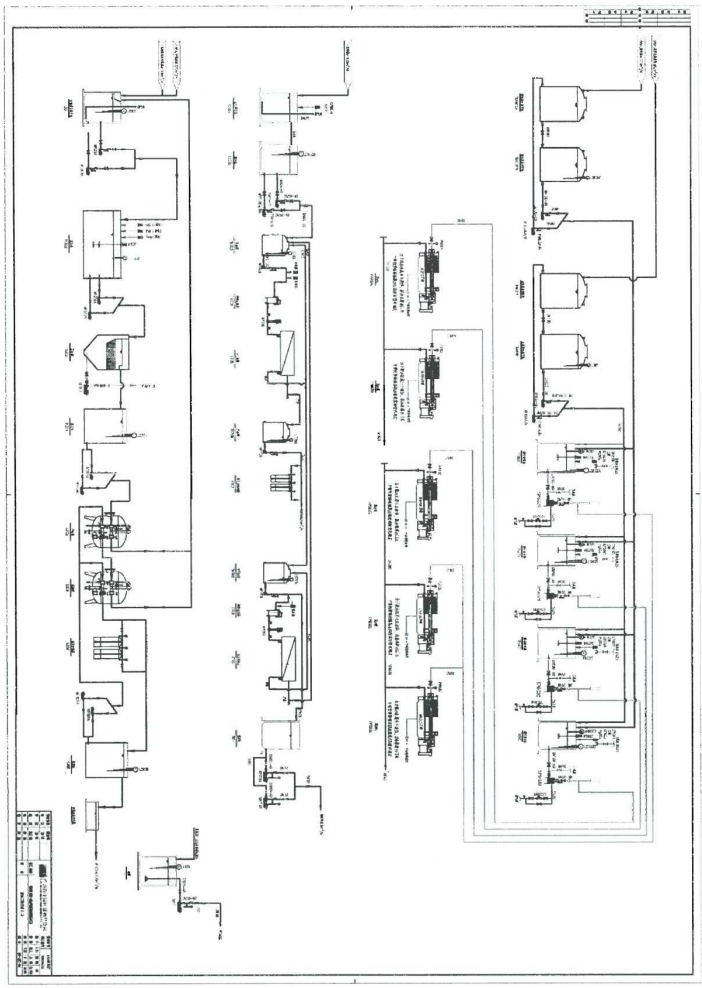

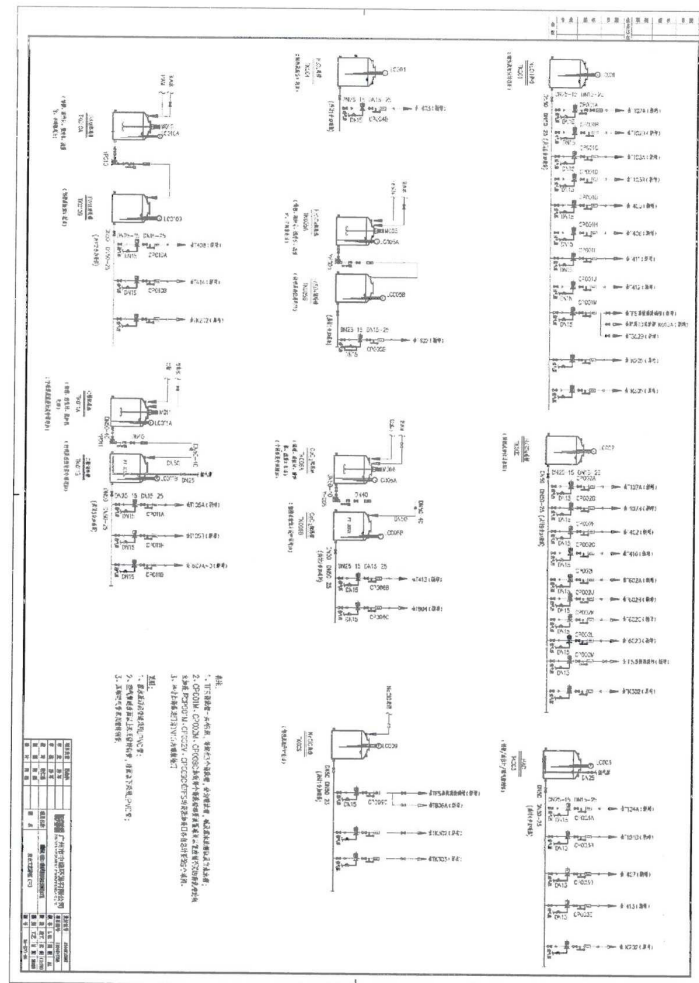

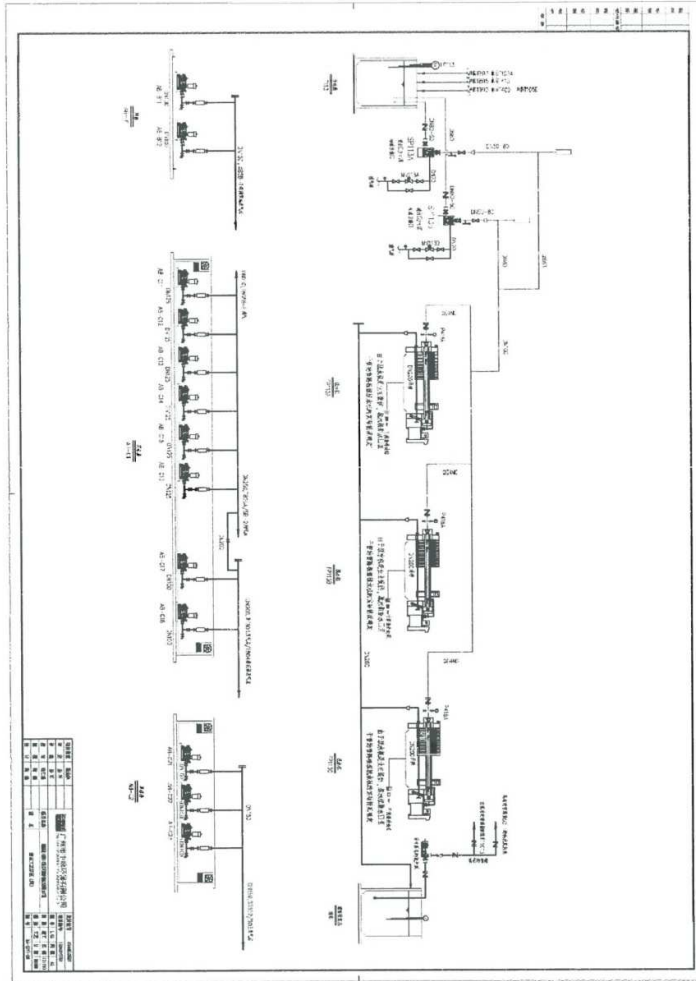

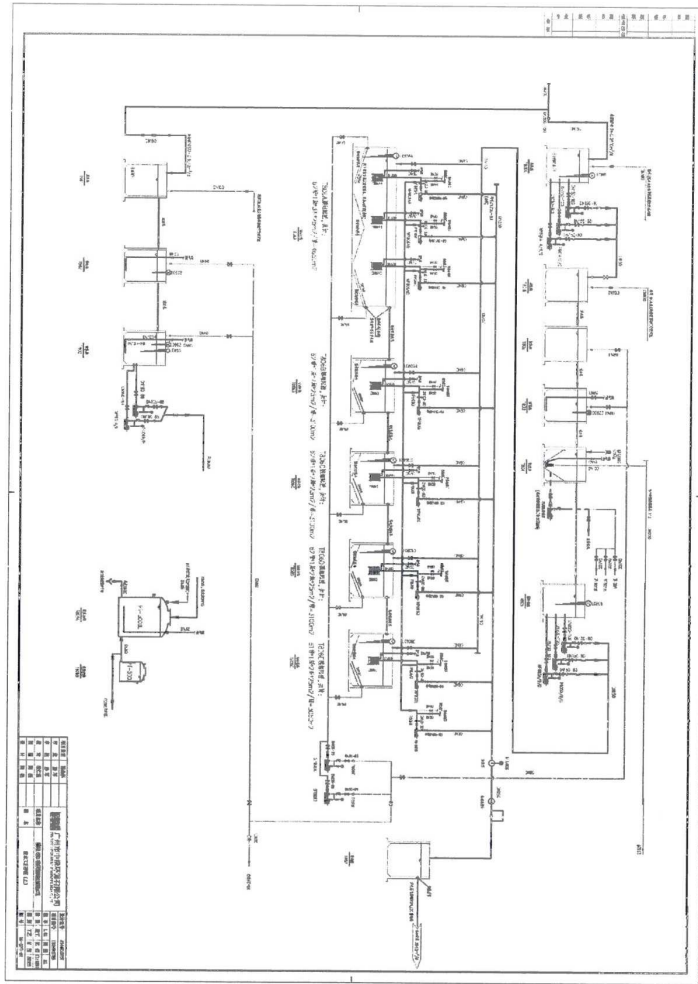

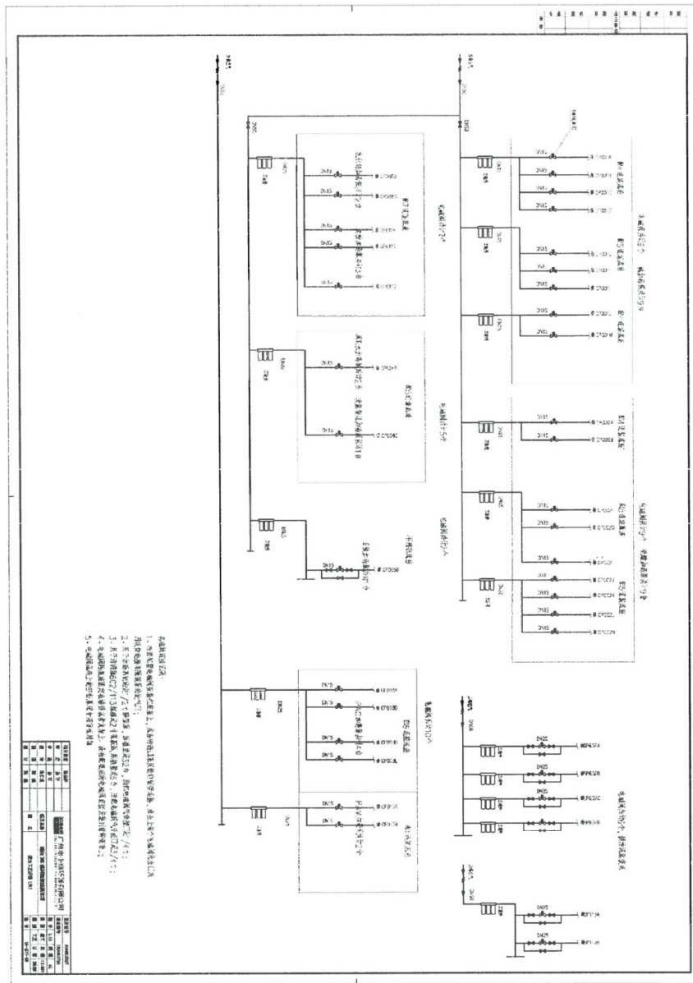

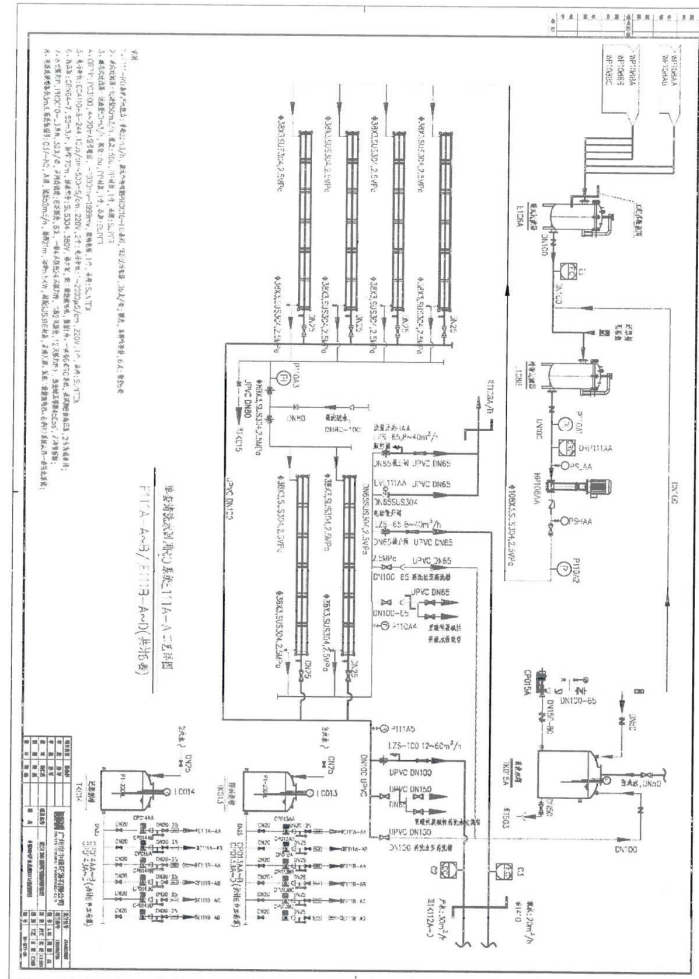

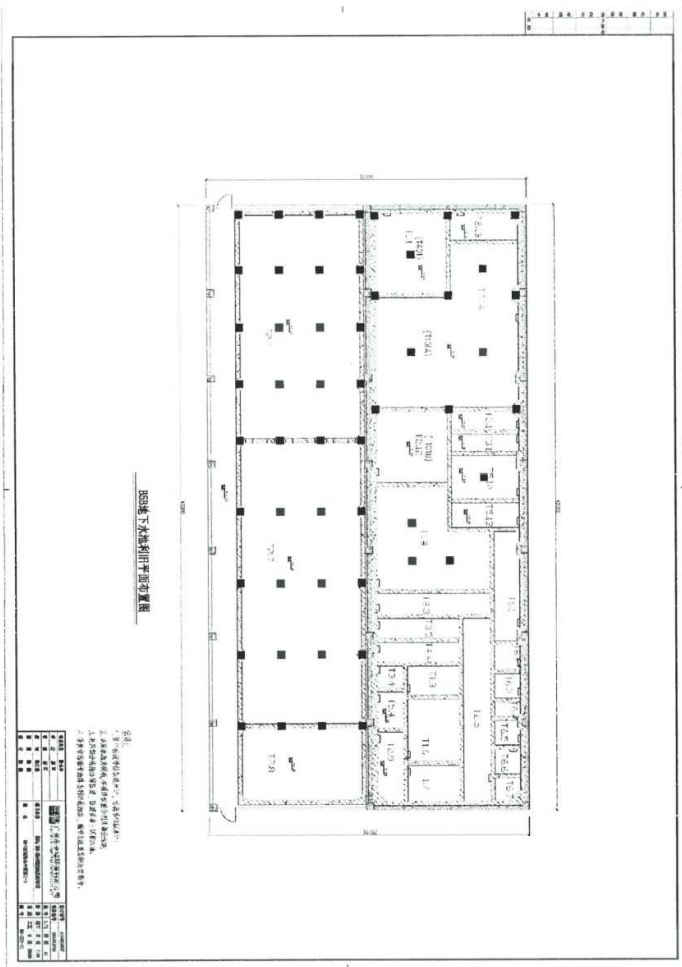

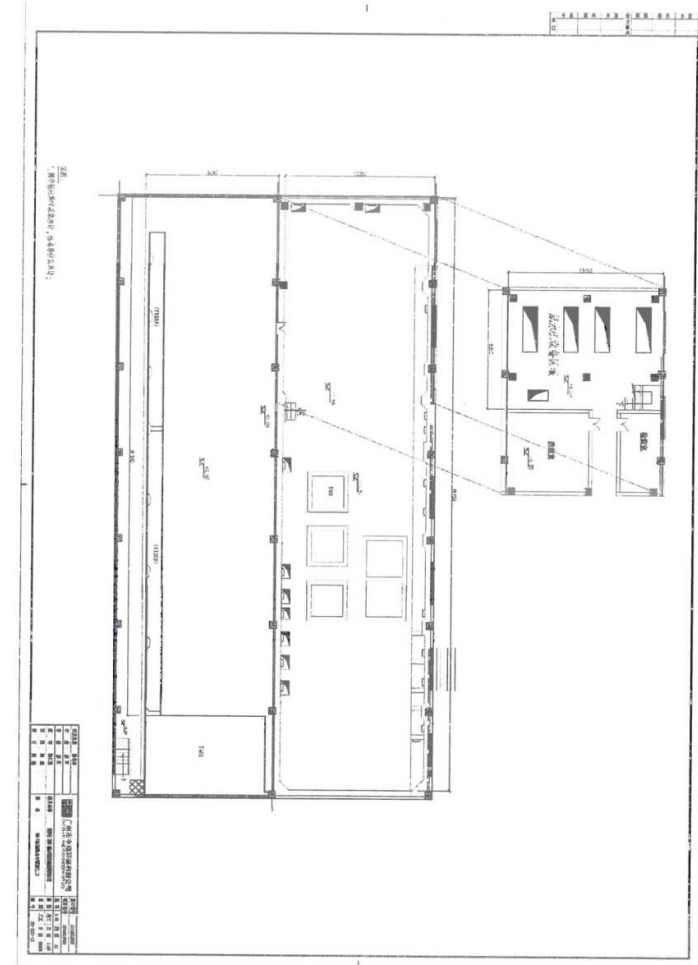

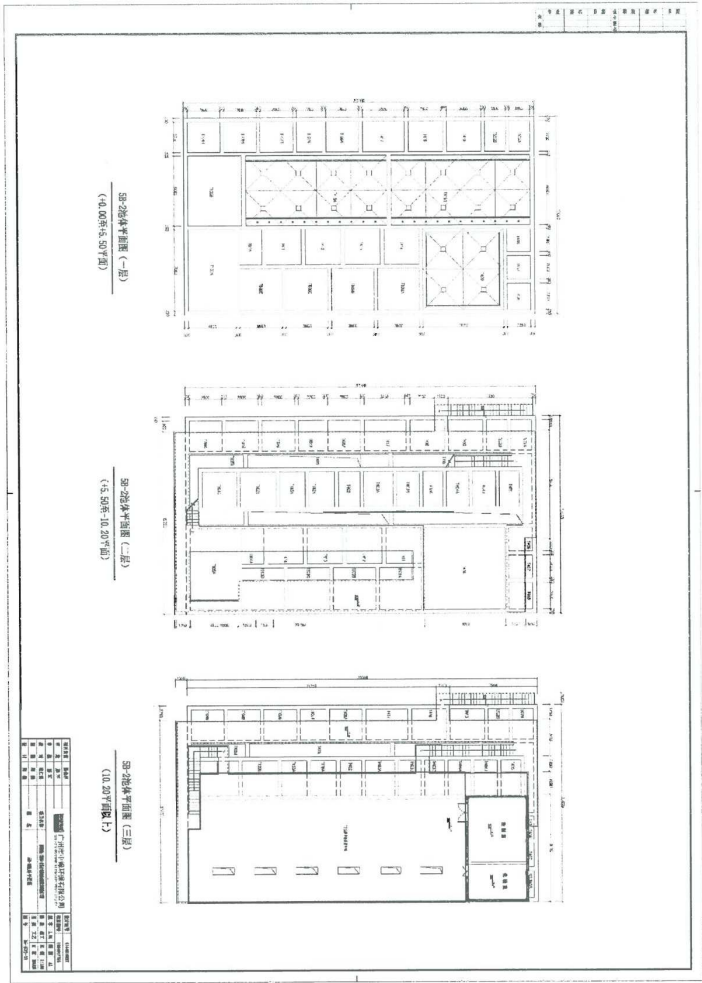

樓層	面積	備註
第一層	100.00	
第二層	100.00	
第三層	100.00	
合計	300.00	

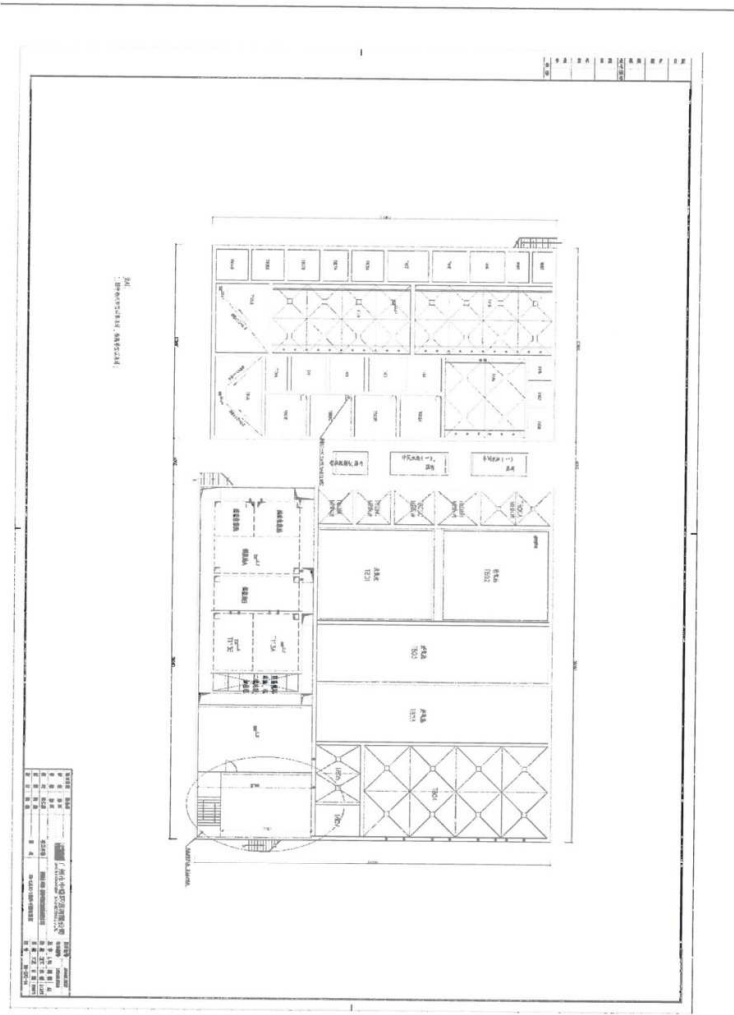

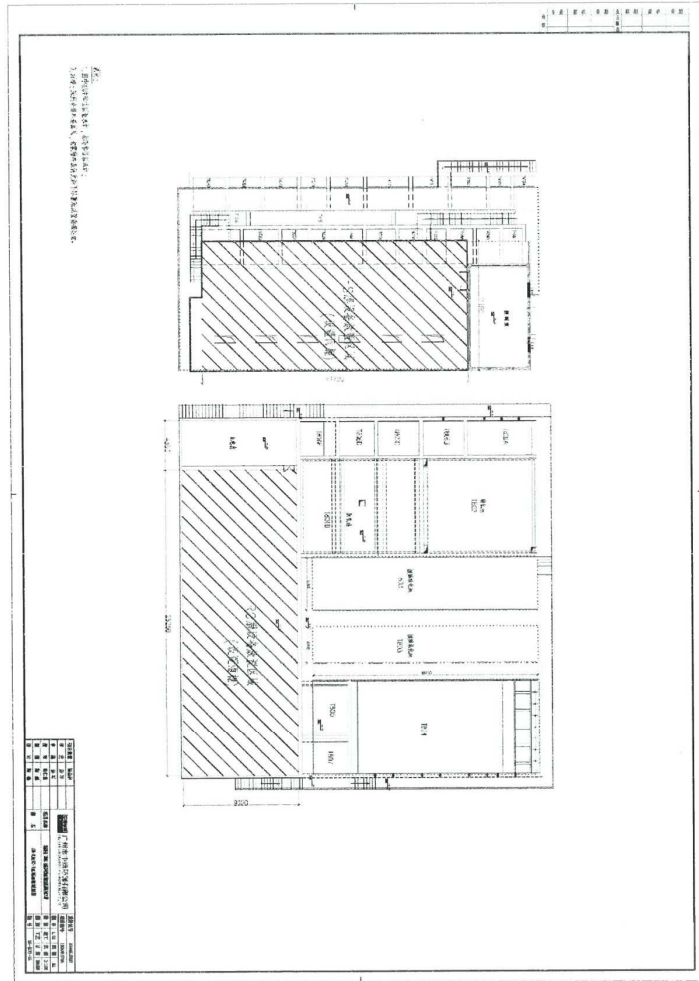

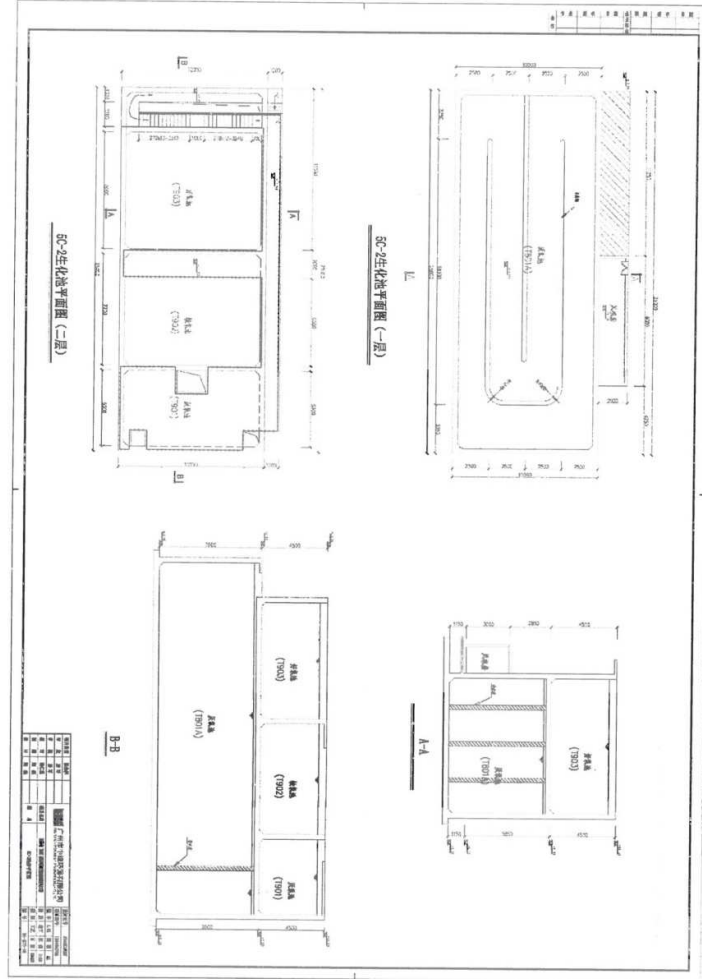

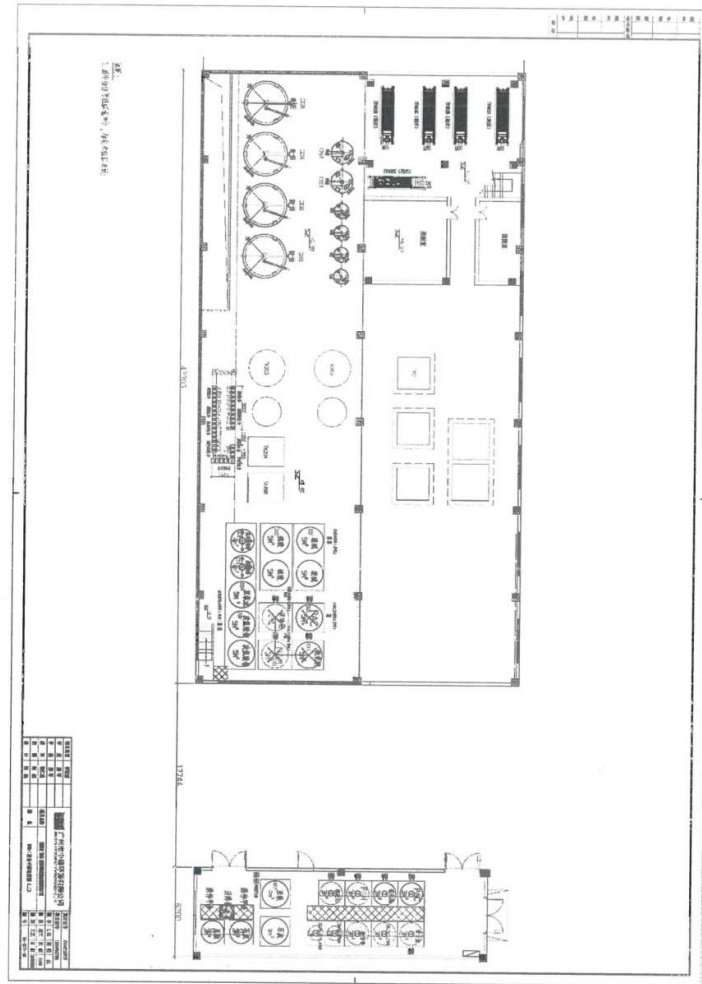

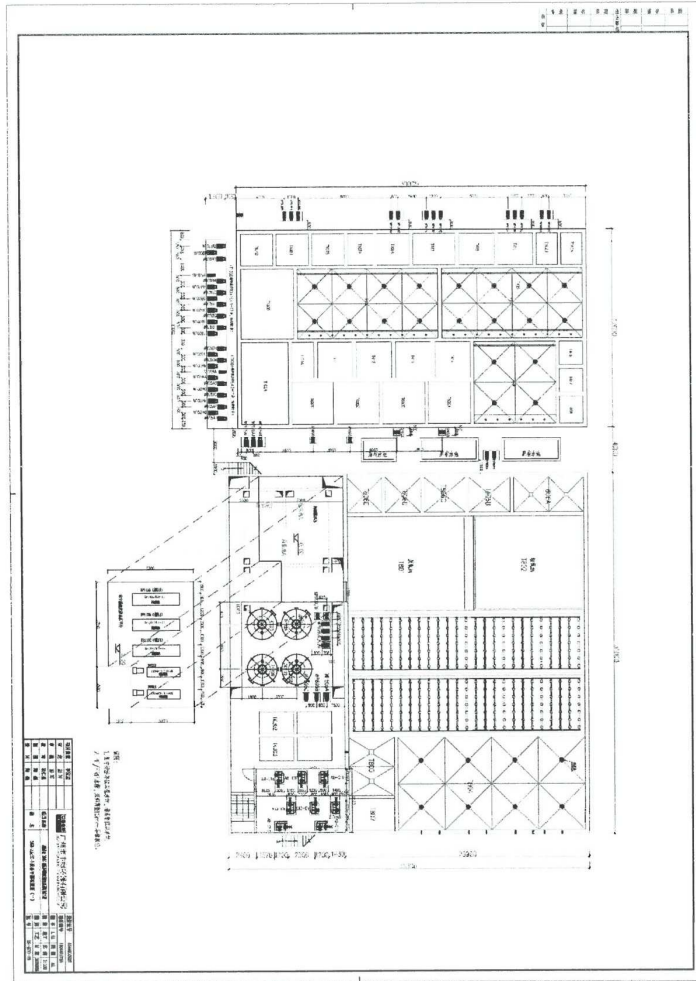

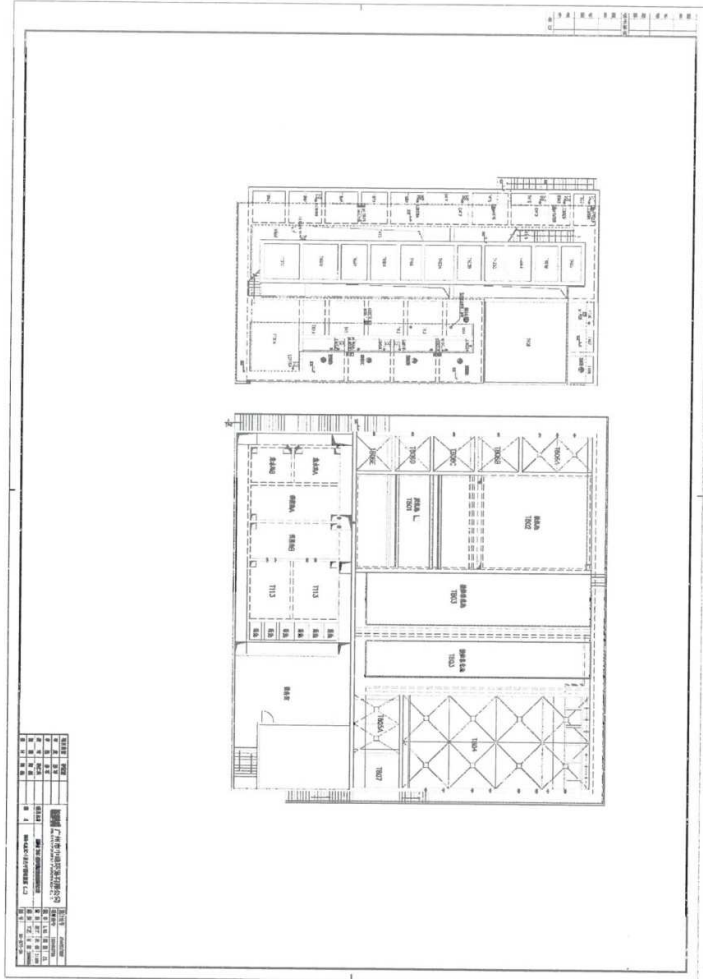

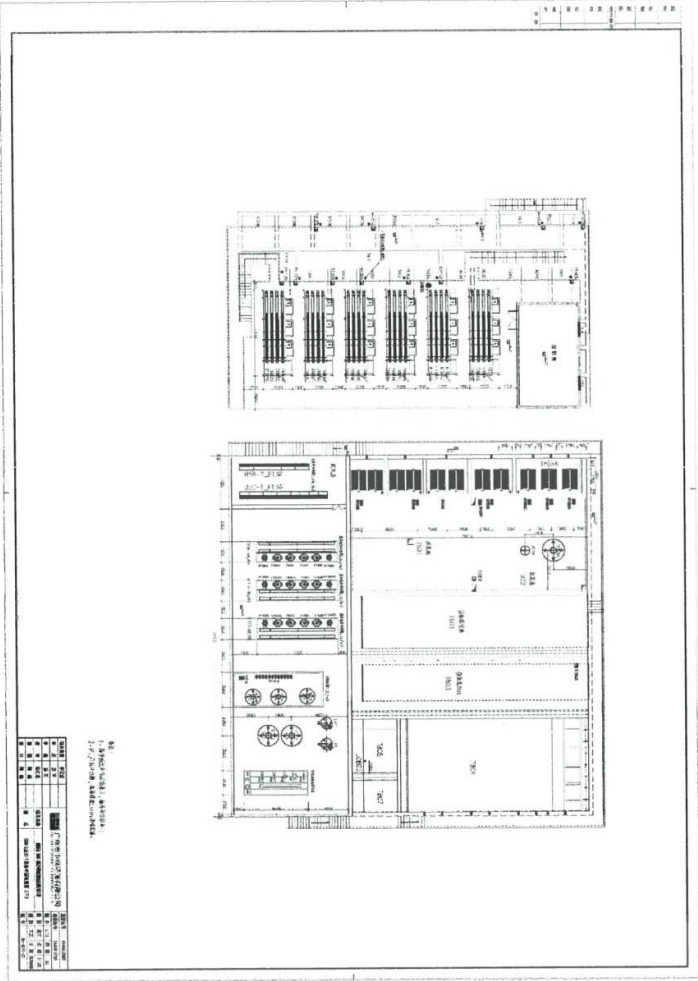

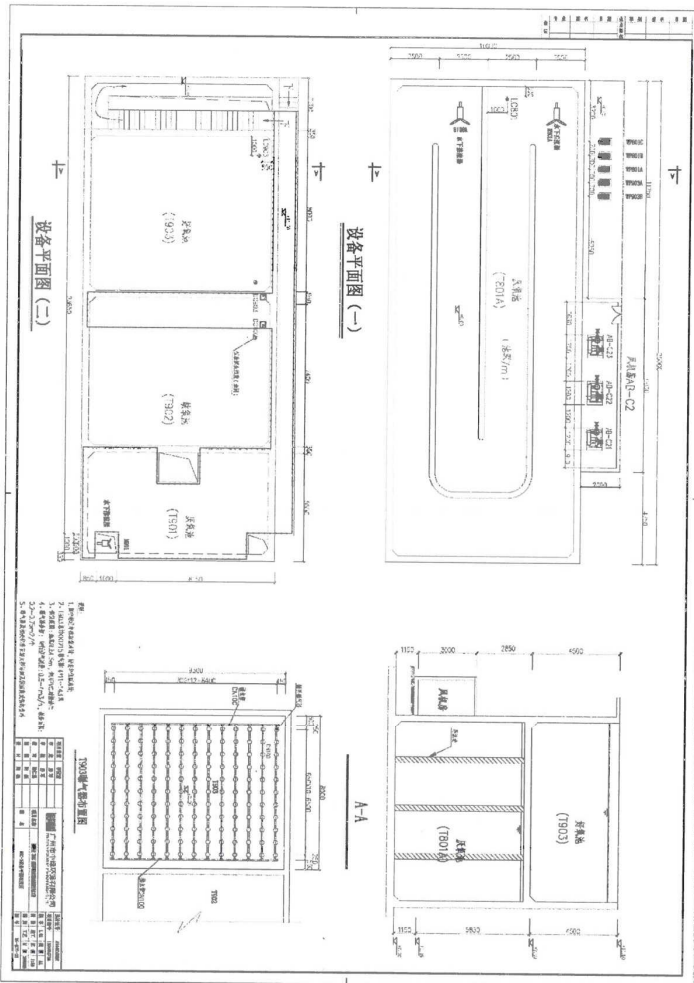

附件五 监测照片



146

